

# SPC-5600 USER

Intel® Core™ i7/i5/i3 Processor (CFL-R) Fanless Embedded System  
4 GigE LAN, 4 USB 3.1, 4 COM, 1 SIM Socket, EN50155

# Manual

## Record of Revision

---

Version	Date	Page	Description	Remark
0.10	2019/09/30	All	Preliminary Release	
1.00	2019/10/05		Official Release	
1.10	2019/10/05	9, 10, 11, 12, 13, 14	Update	
1.20	2019/10/05	4, 6	Update	
1.30	2020/04/21	7	Update	
1.40	2021/03/11	3, 5, 14	Update	
1.50	2021/03/17	1, 3, 5, 71	Update	
1.60	2022/08/26	79-81	Update	
1.70	2023/04/18	All	Update	

## Disclaimer

This manual is released by Vecow Co., Ltd. for reference purpose only. All product offerings and specifications are subject to change without prior notice. It does not represent commitment of Vecow Co., Ltd. Vecow shall not be liable for direct, indirect, special, incidental, or consequential damages arising out of the use of the product or documentation or any infringements upon the rights of third parties, which may result from such use.

## Declaration of Conformity

- FCC** This equipment has been tested and found to comply with the limits for a Class A digital device, pursuant to part 15 of the FCC Rules. These limits are designed to provide reasonable protection against harmful interference when the equipment is operated in a commercial environment. This equipment generates, uses, and can radiate radio frequency energy, and if it is not installed and used in accordance with the instruction manual, it may cause harmful interference to radio communications. Operation of this equipment in a residential area is likely to cause harmful interference in which case the user will be required to correct the interference at his own expense.
- CE** The products described in this manual complies with all applicable European Union (CE) directives if it has a CE marking. For computer systems to remain CE compliant, only CE-compliant parts may be used. Maintaining CE compliance also requires proper cable and cabling techniques.

## Copyright and Trademarks

This document contains proprietary information protected by copyright. No part of this publication may be reproduced in any form or by any means, electric, photocopying, recording or otherwise, without prior written authorization by Vecow Co., Ltd. The rights of all the brand names, product names, and trademarks belong to their respective owners.

## Order Information

---

Part Number	Description
SPC-5600	SPC-5600, 4 GigE LAN, 4 USB 3.1, 4 COM, 1 SIM, 12V DC-in
SPC-5600A	SPC-5600, 4 GigE LAN, 4 USB 3.1, 4 COM, 1 SIM, 9V to 36V DC-in

## Optional Accessories

---

Part Number	Description
DDR4 32G	Certified DDR4 32GB 2666MHz RAM
DDR4 16G	Certified DDR4 16GB 2666MHz RAM
DDR4 8G	Certified DDR4 8GB 2666MHz RAM
DDR4 4G	Certified DDR4 4GB 2666MHz RAM
PWA-160W-WT	160W, 24V, 85V AC to 264V AC Power Adaptor with 3-pin Terminal Block, Wide Temperature -30°C to +70°C
PWA-160W-WT-12V	160W, 12V, 85V AC to 264V AC Power Adaptor with 3-pin Terminal Block, Wide Temperature -30°C to +70°C
PWA-120W	120W, 24V, 90V AC to 264V AC Power Adaptor with 3-pin Terminal Block
PWA-120W-12V	120W, 12V, 90V AC to 264V AC Power Adaptor with 3-pin Terminal Block
Fan Bracket	Fan Bracket for SPC-5600
VESA Mount	VESA Mounting Kit
DIN-RAIL Kit	DIN Rail and VESA Mounting Kit
4G Module	Mini PCIe 4G/GPS Module with Antenna
WiFi & Bluetooth	WiFi & Bluetooth Module with Antenna

# Table of Contents

<b>CHAPTER 1</b>	<b>GENERAL INTRODUCTION</b>	<b>1</b>
	1.1 Overview	1
	1.2 Features	2
	1.3 Product Specification	3
	1.3.1 Specifications of SPC-5600	3
	1.3.2 Specifications of SPC-5600A	5
	1.4 Supported CPU List	7
	1.5 Mechanical Dimension	8
	1.5.1 Dimensions of SPC-5600	8
	1.5.2 Dimensions of SPC-5600A	8
<b>CHAPTER 2</b>	<b>GETTING TO KNOW YOUR SPC-5600</b>	<b>9</b>
	2.1 Packing List	9
	2.2 Front Panel I/O & Functions	10
	2.3 Rear Panel I/O & Functions	16
	2.4 Connector/Jumper Locations	18
	2.5 Jumper Settings	29
<b>CHAPTER 3</b>	<b>SYSTEM SETUP</b>	<b>33</b>
	3.1 How to Open Your SPC-5600	33
	3.2 Installing CPU	35
	3.3 Installing DDR4 SO-DIMM Modules	36
	3.4 Installing Mini PCIe Card	37
	3.5 Installing Antenna Cable	38
	3.6 Installing SIM Card	39
	3.7 Installing SSD/HDD	40
	3.8 Installing Fan Bracket	42
	3.9 Mounting Your SPC-5600	44
<b>CHAPTER 4</b>	<b>BIOS SETUP</b>	<b>46</b>
	4.1 Entering BIOS Setup	46

4.2 Main	47
4.3 Advanced	47
4.4 Chipset	58
4.5 Security	64
4.6 Boot	66
4.7 Save & Exit	67
<b>APPENDIX A : SOFTWARE GUIDE</b>	<b>68</b>
<b>APPENDIX B : Software Functions</b>	<b>70</b>
<b>APPENDIX C : Power Consumption</b>	<b>71</b>
<b>APPENDIX D : Supported Memory &amp; Storage List</b>	<b>73</b>
<b>APPENDIX E : Install Win11 (BIOS TPM Setting)</b>	<b>75</b>

# 1

## GENERAL INTRODUCTION

### 1.1 Overview

Vecow SPC-5600 Series is a high-performance compact Fanless Embedded System. LGA1151 Socket supports 8-core 9th/8th Generation Intel® Core™ i7/i5/i3 processor (CFL-R/CFL-S) running with Intel® H310 chipset, dual channel DDR4 2666MHz up to 64GB ECC memory, advanced Intel® UHD Graphics 630 supporting DirectX 12 and OpenGL 4.5 API, up to Ultra HD 4K resolution, SPC-5600 delivers new generation CPU & chipset performance, power efficiency, and graphics performance; multiple PCIe 3.0 (8GT/s), SATA III (6Gbps), USB 3.1 (5Gbps), GigE (1Gbps) LAN and wireless connections make high-speed data conveying possible. Vecow SPC-5600 Series Fanless Embedded System delivers outstanding performance, compact integrated features, user-friendly, smart manageability and trusted reliability for your edge computing applications.

Fanless -25°C to 60°C operating temperature, onboard DVI-D and dual DisplayPort display interfaces for dual display, 4 GigE LAN ports with iAMT 12.0, 4 external USB 3.1 connections, WiFi/4G/3G/LTE/GPRS/UMTS wireless data transfer, 2 SATA III, 4 COM RS-232/422/485, 9V to 36V wide range power input or 12V DC power input, TPM 2.0, Watchdog Timer, Wake on LAN and PXE smart remote management, remote power switch, EN50155 and EN50121-3-2 compliant, Vecow SPC-5600 Series Fanless Embedded System serves compact integrated & flexible functions for your project requirements.

Powered by 8th gen Intel® Core™ i7/i5/i3 processor (Coffee Lake) running with Intel® H310 chipset, outstanding performance, compact integrated features, user-friendly, smart manageability and trusted reliability, Vecow SPC-5600 Fanless Embedded System is your smart solution for Machine Vision, Vehicle Computing, Smart Manufacturing, In-vehicle Infotainment, Intelligent Control and any AIoT/Industry 4.0 applications.



## 1.2 Features

- 8 Core 9th/8th Gen Intel® Core™ i7/i5/i3 Processor (CFL-R/CFL-S) running with Intel® H310 Chipset
- DDR4 2666MHz memory, up to 64GB
- Fanless -25°C to 60°C Operating Temperature, optional supports operation with fan
- 2 DisplayPort and 1 DVI display interfaces support dual independent displays, up to 4K resolution
- 4 USB 3.1, 4 COM RS-232/422/485
- 4 Independent Intel® GigE LAN, iAMT 12.0 supported
- Supports WiFi/4G/3G/LTE/GPRS/UMTS
- 2 Mini PCIe sockets for PCIe/USB/SIM Card/mSATA expansions
- 9V to 36V wide range DC Power Input
- TPM 2.0 supported

## 1.3 Product Specification

### 1.3.1 Specifications of SPC-5600

<b>System</b>	
Processor	8 cores Intel® Xeon®/Core™ i7/i5/i3 Processor (CFL-R/CFL-S)
Chipset	Intel® H310 Chipset
BIOS	AMI
SIO	IT8786E
Memory	<ul style="list-style-type: none"><li>• DDR4 2666MHz (ECC/Non-ECC)</li><li>• Up to 64GB</li><li>• 2 260-pin SO-DIMM Socket</li></ul>
<b>I/O Interface</b>	
Serial	4 COM RS-232/422/485 (ESD 8KV)
USB	<ul style="list-style-type: none"><li>• 4 USB 3.1 (External)</li><li>• 2 USB 2.0 (Internal)</li></ul>
LED	Power, HDD
SIM Card	1 SIM Card Socket (Internal)
<b>Expansion</b>	
Mini PCIe	<ul style="list-style-type: none"><li>• 2 Mini PCIe sockets</li><li>• 1 Full-size for PCIe/USB/SIM Card</li><li>• 1 Full-size for PCIe/USB/mSATA</li></ul>
<b>Graphics</b>	
Graphics Processor	Intel® UHD Graphics 630
Interface	Supports dual display : <ul style="list-style-type: none"><li>• 2 DisplayPort : Up to 4096 x 2304 @60Hz</li><li>• 1 DVI-D : Up to 1920 x 1080 @60Hz</li></ul>
<b>Storage</b>	
SATA	2 SATA III (6Gbps)
mSATA	1 SATA III (Mini PCIe Type, 6Gbps)
Storage Device	2 2.5" SSD/HDD Bracket (Internal)
<b>Audio</b>	
Audio Codec	Realtek ALC888S-VD, 7.1 Channel HD Audio
Audio Interface	1 Mic-in, 1 Line-out
<b>Ethernet</b>	
LAN 1	Intel® I219LM GigE LAN supports iAMT 12.0
LAN 2	Intel® I210 GigE LAN
LAN 3	Intel® I210 GigE LAN
LAN 4	Intel® I210 GigE LAN

<b>Power</b>	
Input Voltage	12V DC-in (±5%)
Power Interface	3-pin Terminal Block : V+, V-, Frame Ground
Remote Switch	2-pin Terminal Block
<b>Others</b>	
TPM	Optional Infineon SLB9665 supports TPM 2.0, LPC interface
Watchdog Timer	Reset : 1 to 255 sec./min. per step
Smart Management	Wake on LAN, PXE supported
HW Monitor	Monitoring temperature, voltages. Auto throttling control when CPU overheats.
<b>Software Support</b>	
OS	Windows 10, Linux
<b>Mechanical</b>	
Dimension (W x D x H)	209.0mm x 150.0mm x 75.0mm (8.23" x 5.93" x 2.95")
Weight	2.4 kg (5.29 lbs)
Mounting	<ul style="list-style-type: none"> <li>• Wallmount by mounting bracket</li> <li>• DIN Rail Mount (Optional)</li> </ul>
<b>Environment</b>	
Operating Temperature	<b>35W TDP CPU</b> : -25°C to 60°C (-13°F to 140°F) <b>65W TDP CPU w/Fan Bracket</b> : -25°C to 60°C (-13°F to 140°F)
Storage Temperature	-40°C to 85°C (-40°F to 185°F)
Humidity	5% to 95% humidity, non-condensing
Relative Humidity	95% at 60°C
Shock	<ul style="list-style-type: none"> <li>• IEC 60068-2-27</li> <li>• SSD : 50G @ wallmount, Half-sine, 11ms</li> </ul>
Vibration	<ul style="list-style-type: none"> <li>• IEC 60068-2-64</li> <li>• SSD : 5Grms, 5Hz to 500Hz, 3 Axis</li> </ul>
EMC	CE, FCC, EN50155, EN50121-3-2

### 1.3.2 Specifications of SPC-5600A

<b>System</b>	
Processor	8 cores Intel® Xeon®/Core™ i7/i5/i3 Processor (CFL-R/CFL-S)
Chipset	Intel® H310 Chipset
BIOS	AMI
SIO	IT8786E
Memory	<ul style="list-style-type: none"> <li>• DDR4 2666MHz (ECC/Non-ECC)</li> <li>• Up to 64GB</li> <li>• 2 260-pin SO-DIMM Socket</li> </ul>
<b>I/O Interface</b>	
Serial	4 COM RS-232/422/485 (ESD 8KV)
USB	<ul style="list-style-type: none"> <li>• 4 USB 3.1 (External)</li> <li>• 2 USB 2.0 (Internal)</li> </ul>
LED	Power, HDD
SIM Card	1 SIM Card Socket (Internal)
<b>Expansion</b>	
Mini PCIe	2 Mini PCIe sockets <ul style="list-style-type: none"> <li>• 1 Full-size for PCIe/USB/SIM Card</li> <li>• 1 Full-size for PCIe/USB/mSATA</li> </ul>
<b>Graphics</b>	
Graphics Processor	Intel® UHD Graphics 630
Interface	Supports dual display : <ul style="list-style-type: none"> <li>• 2 DisplayPort : Up to 4096 x 2304 @60Hz</li> <li>• 1 DVI-D : Up to 1920 x 1080 @60Hz</li> </ul>
<b>Storage</b>	
SATA	2 SATA III (6Gbps)
mSATA	1 SATA III (Mini PCIe Type, 6Gbps)
Storage Device	2 2.5" SSD/HDD Bracket (Internal)
<b>Audio</b>	
Audio Codec	Realtek ALC888S-VD, 7.1 Channel HD Audio
Audio Interface	1 Mic-in, 1 Line-out
<b>Ethernet</b>	
LAN 1	Intel® I219LM GigE LAN supports iAMT 12.0
LAN 2	Intel® I210 GigE LAN
LAN 3	Intel® I210 GigE LAN
LAN 4	Intel® I210 GigE LAN

<b>Power</b>	
Input Voltage	9V to 36V DC-in
Power Interface	3-pin Terminal Block : V+, V-, Frame Ground
Remote Switch	2-pin Terminal Block
<b>Others</b>	
TPM	Optional Infineon SLB9665 supports TPM 2.0, LPC interface
Watchdog Timer	Reset : 1 to 255 sec./min. per step
Smart Management	Wake on LAN, PXE supported
HW Monitor	Monitoring temperature, voltages. Auto throttling control when CPU overheats.
<b>Software Support</b>	
OS	Windows 10, Linux
<b>Mechanical</b>	
Dimension (W x D x H)	209.0mm x 150.0mm x 75.0mm (8.23" x 5.93" x 2.95")
Weight	2.7 kg (5.95 lbs)
Mounting	<ul style="list-style-type: none"> <li>• Wallmount by mounting bracket</li> <li>• DIN Rail Mount (Optional)</li> </ul>
<b>Environment</b>	
Operating Temperature	<b>35W TDP CPU</b> : -25°C to 60°C (-13°F to 140°F) <b>65W TDP CPU w/Fan Bracket</b> : -25°C to 60°C (-13°F to 140°F)
Storage Temperature	-40°C to 85°C (-40°F to 185°F)
Humidity	5% to 95% humidity, non-condensing
Relative Humidity	95% at 60°C
Shock	<ul style="list-style-type: none"> <li>• IEC 60068-2-27</li> <li>• SSD : 50G @ wallmount, Half-sine, 11ms</li> </ul>
Vibration	<ul style="list-style-type: none"> <li>• IEC 60068-2-64</li> <li>• SSD : 5Grms, 5Hz to 500Hz, 3 Axis</li> </ul>
EMC	CE, FCC, EN50155, EN50121-3-2

## 1.4 Supported CPU List

Processor No.	Cores	TDP	Cache	Max. Frequency	ECC Memory
Intel® Core™ i7-9700E	8	65W	12M	Up to 4.4GHz	N
Intel® Core™ i7-9700TE	8	35W	12M	Up to 3.8GHz	N
Intel® Core™ i7-8700	6	65W	12M	Up to 4.6GHz	N
Intel® Core™ i7-8700T	6	35W	12M	Up to 4.0GHz	N
Intel® Core™ i5-9500E	6	65W	9M	Up to 4.2GHz	N
Intel® Core™ i5-9500TE	6	35W	9M	Up to 3.6GHz	N
Intel® Core™ i5-8500	6	65W	9M	Up to 4.1GHz	N
Intel® Core™ i5-8500T	6	35W	9M	Up to 3.5GHz	N
Intel® Core™ i3-9100E	4	65W	6M	Up to 3.7GHz	N
Intel® Core™ i3-9100TE	4	35W	6M	Up to 3.2GHz	N
Intel® Core™ i3-8100	4	65W	6M	Up to 3.6GHz	N
Intel® Core™ i3-8100T	4	35W	6M	Up to 3.1GHz	N

# 1.5 Mechanical Dimension

## 1.5.1 Dimensions of SPC-5600

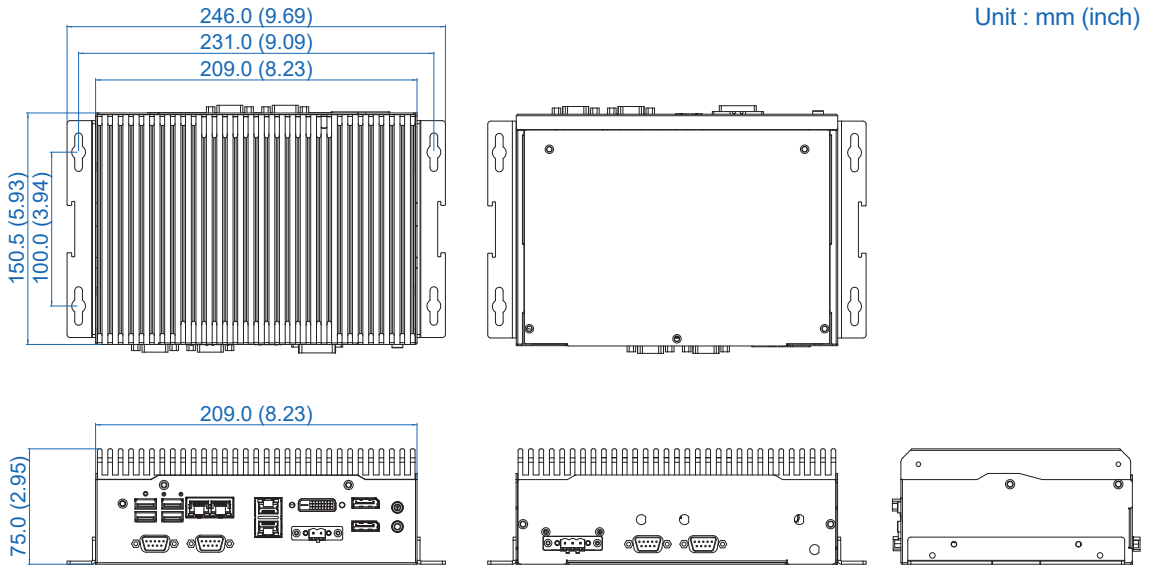

## 1.5.2 Dimensions of SPC-5600A

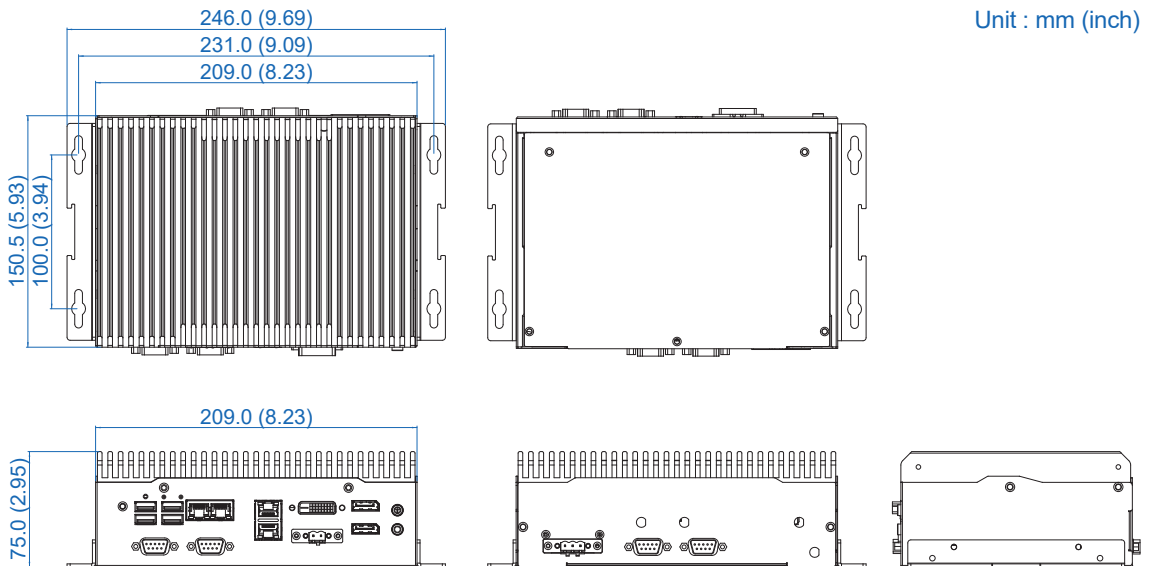

# 2

## GETTING TO KNOW YOUR SPC-5600

### 2.1 Packing List

Item	Description	Qty
1	SPC-5600 Fanless Embedded System	1
2	SPC-5600 accessory box, which contains <ul style="list-style-type: none"><li>• Wall-mounting bracket(SET)</li><li>• KHS#6-32x6 screw for wall-mounting</li><li>• M2.5x6 screw for Mini PCIe Slot</li><li>• 3-pin pluggable terminal block</li><li>• 2-pin pluggable terminal block</li><li>• Foot Pad</li><li>• SSD/HDD Bracket KH-M3x6L Ni</li><li>• PHILLPISM4x16L withwasher, Ni</li></ul>	1 4 2 1 1 4 8 4



## 2.2 Front Panel I/O & Functions

In Vecow SPC-5600 series family, all I/O connectors are located on front panel and rear panel. Most of the general connections to computer device, such as USB, LAN Jack, DVI-D, Display Port and any are placed on the front panel.

### 2.2.1 Reset Tact Switch

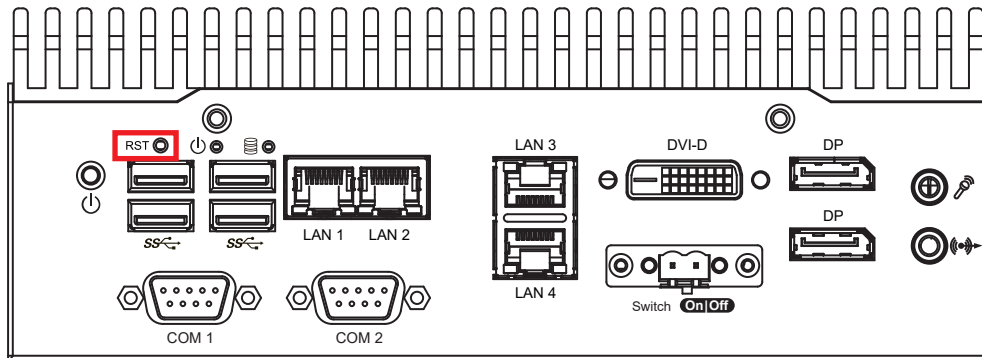

It is a hardware reset switch. Use this switch to reset the system without power off the system. Press the Reset Switch for a few seconds, then reset will be enabled.

### 2.2.2 Power Button

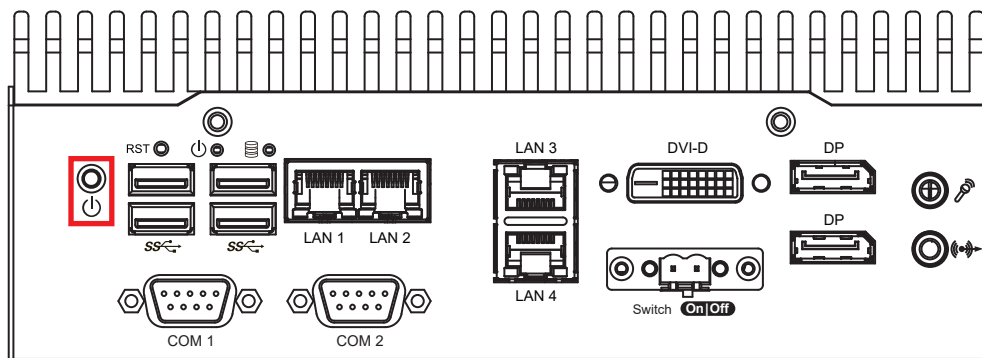

The Power Button is a non-latched switch.

To power off the system, you can either command shutdown by OS operation, or just simply press the power button.

If system error, you can just press the power button for 4 seconds to shut down the machine directly.

Please do note that a 4-second interval between each 2 power-on/power-off operation is necessary in normal working status. (For example, once turning off the system, you have to wait for 4 seconds to initiate another power-on operation).

### 2.2.3 PWR & HDD LED Indicator

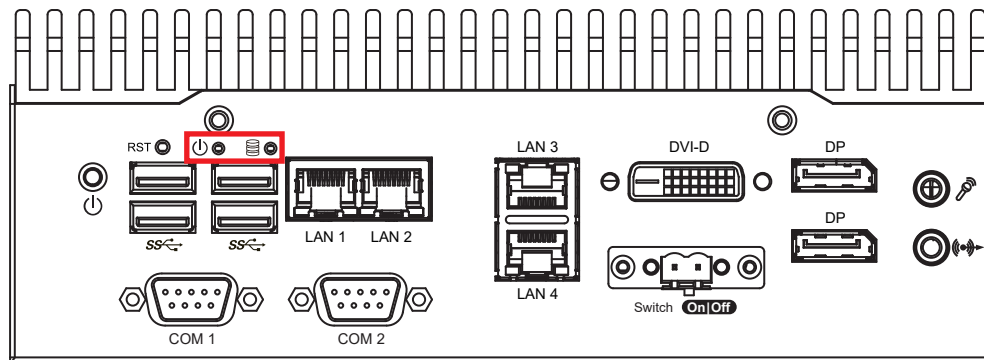

**HDD LED/Yellow** : A Hard Disk. If the LED is on, it indicates that the system's storage is functional. If it is off, it indicates that the system's storage is not functional. If it is flashing, it indicates data access activities.

**Power LED/Green** : If the LED is solid green, it indicates that the system is powered on.

LED Color	Indication	System Status
Yellow	HDD	<ul style="list-style-type: none"> <li>• On/Off : Storage status, function or not.</li> <li>• Twinkling : Data transferring.</li> </ul>
Green	Power	System power status (on/off)

### 2.2.4 DVI-D Connector

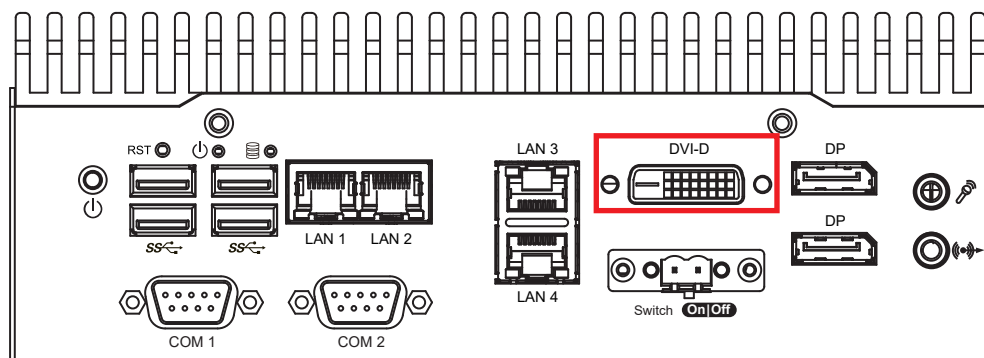

The DVI-D connector on the front panel supports DVI display. This connector can either output DVI signal. The DVI output mode supports up to 1920 x 1200 resolution and output mode supports up to 1920 x 1200 resolution. The DVI is automatically selected according to the display device connected. You will need a DVI-D cable when connecting to a display device.

## 2.2.5 DisplayPort

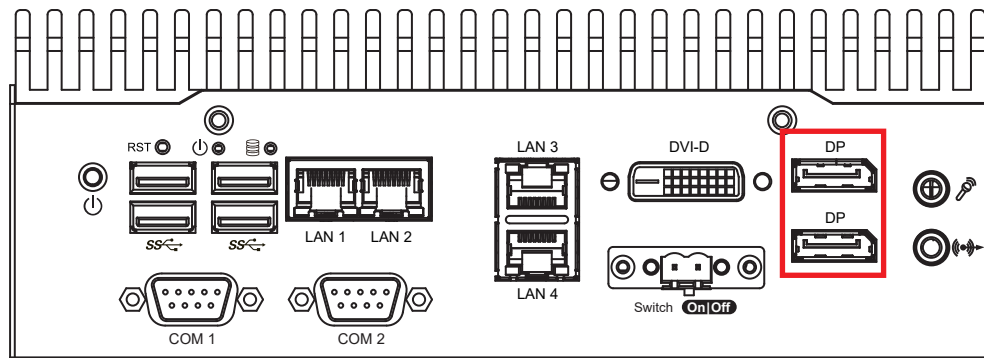

Onboard Display Port support auxiliary channel dual mode, connection supports up to 4096 x 2304 resolution at 60Hz.

## 2.2.6 USB 3.1

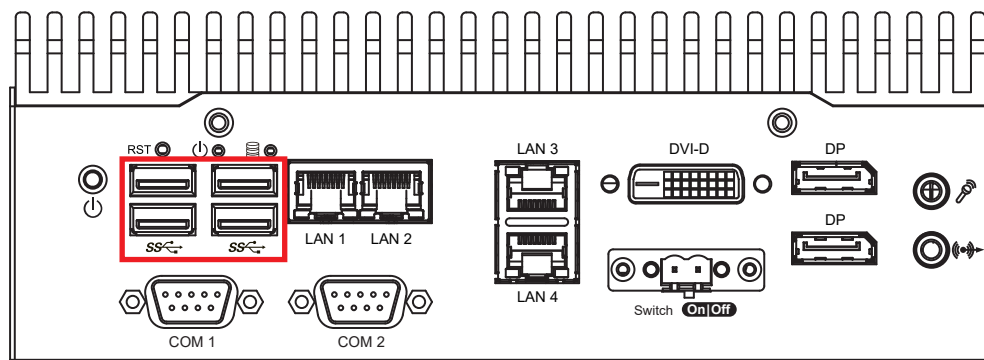

There are 4 USB 3.1 connections available supporting up to 10GB per second data rate in the front side of EXBC-1000. It also compliant with the requirements of Super Speed (SS), high speed (HS), full speed (FS) and low speed (LS).

## 2.2.7 Ethernet Port

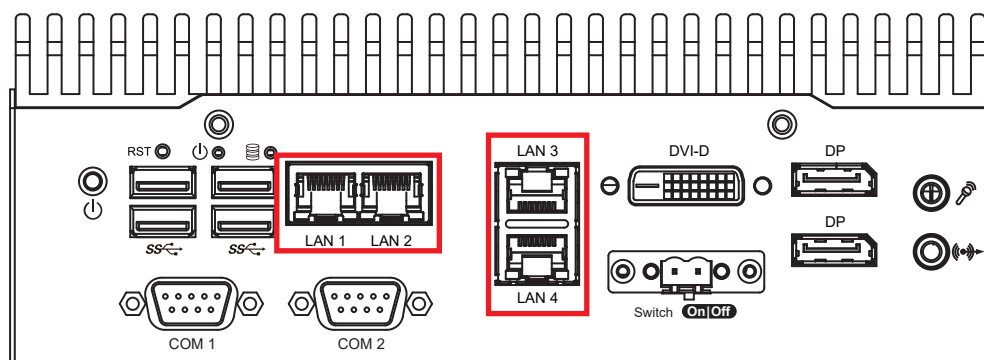

There are 4 8-pin RJ-45 jacks supporting 10/100/1000 Mbps Ethernet connections in the front side. LAN 1 is powered by Intel® i219 Ethernet Phy; LAN 2, LAN 3, LAN 4 is powered by Intel® I210 Ethernet engine. When LAN 1 work in normal status, iAMT 11.0 function is enabled.

Using suitable RJ-45 cable, you can connect the system to a computer, or to any other devices with Ethernet connection, for example, a hub or a switch. Moreover, both of LAN 1 and LAN 2, LAN 3, LAN 4 supports Wake on LAN and Pre-boot functions. The pin-outs of LAN 1 and LAN 2, LAN 3, LAN 4 are listed as follows :

Pin No.	10/100 Mbps	1000Mbps
1	E_TX+	MDI0_P
2	E_TX-	MDI0_N
3	E_RX+	MDI1_P
4	-----	MDI2_P
5	-----	MDI2_N
6	E_RX-	MDI1_N
7	-----	MDI3_P
8	-----	MDI3_N

Each LAN port is supported by standard RJ-45 connector with LED indicators to present Active/Link/Speed status of the connection.

The LED indicator on the right bottom corner lightens in solid green when the cable is properly connected to a 100Mbps Ethernet network; The LED indicator on the right bottom corner lightens in solid orange when the cable is properly connected to a 1000Mbps Ethernet network; The left LED will keep twinkling/off when Ethernet data packets are being transmitted/received.

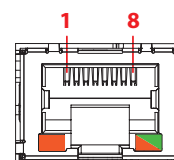

LED Location	LED Color	10Mbps	100Mbps	1000Mbps
Right	Green/Orange	Off	Solid Green	Solid Orange
Left	Yellow	Twinkling Yellow	Twinkling Yellow	Twinkling Yellow

## 2.2.8 Remote Power On/Off Switch

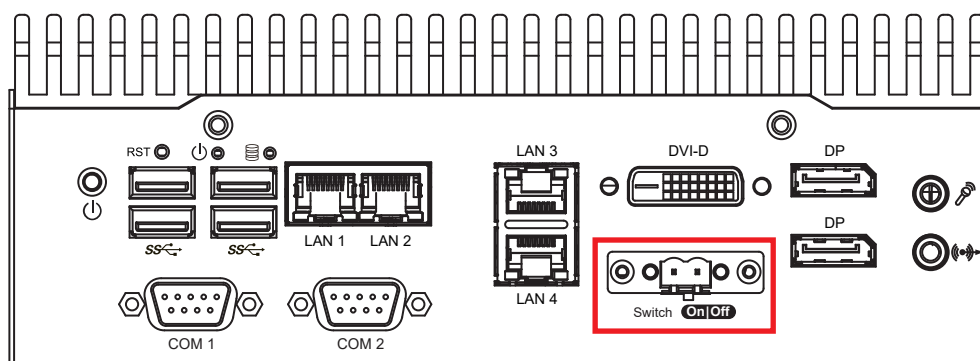

It is a 2-pin power-on or power-off switch through Phoenix Contact terminal block. You could turn on or off the system power by using this contact. This terminal block supports dual function of soft power-on/power-off (instant off or delay 4 second), and suspend mode.

Pin No.	Definition
1	SW+
2	SW-

## 2.2.9 Audio Connector

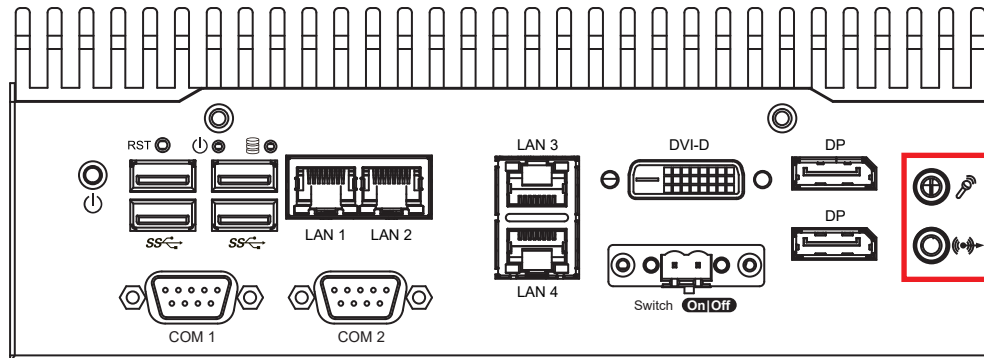

There are 2 audio connectors, Mic-in and Line-out, in the front side of SPC-5600. Onboard Realtek ALC888S-VD audio codec supports 7.1 channel HD audio and fully complies with Intel® High Definition Audio (Azalia) specifications.

To utilize the audio function in Windows platform, you need to install corresponding drivers for both Intel Sunrise Point chipset and Realtek ALC888S-VD codec.

## 2.2.10 Serial Port

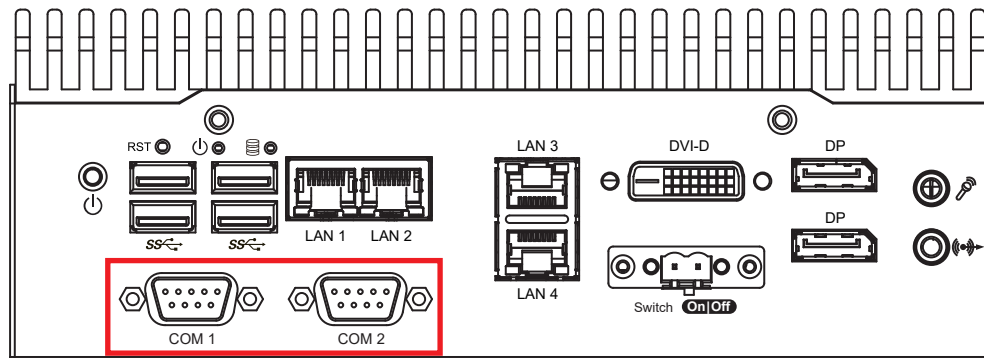

Serial port 1 to 2 (COM 1 to 2) can be configured for RS-232, RS-422, or RS-485 with auto flow control communication. The default definition of COM 1 and COM 2 is RS-232, if you want to change to RS-422 or RS-485, you can find the setting in BIOS.

BIOS Setting	Function
COM 1 COM 2	RS-232
	RS-422 (5-wire)
	RS-422 (9-wire)
	RS-485
	RS-485 w/z auto-flow control
	RI (Default)

The pin assignments are listed in the following table :

Serial Port	Pin No.	RS-232	RS-422 (5-wire)	RS-422 (9-wire)	RS-485 (3-wire)
1, 2	1	DCD	TXD-	TXD-	DATA-
	2	RXD	TXD+	TXD+	DATA+
	3	TXD	RXD+	RXD+	-----
	4	DTR	RXD-	RXD-	-----
	5	GND	GND	GND	GND
	6	DSR	-----	RTS-	-----
	7	RTS	-----	RTS+	-----
	8	CTS	-----	CTS+	-----
	9	RI	-----	CTS-	-----

## 2.3 Rear Panel I/O & Functions

### 2.3.1 Power Terminal Block

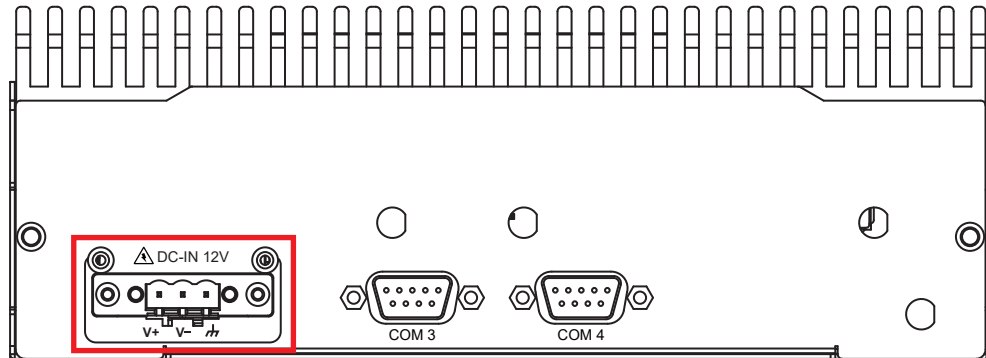

SPC-5600 system only supports 12V DC power input by terminal block in the rear side. In normal power operation, power LED lightens in solid green.

Pin No.	Definition
1	V+
2	V-
3	Chassis Ground

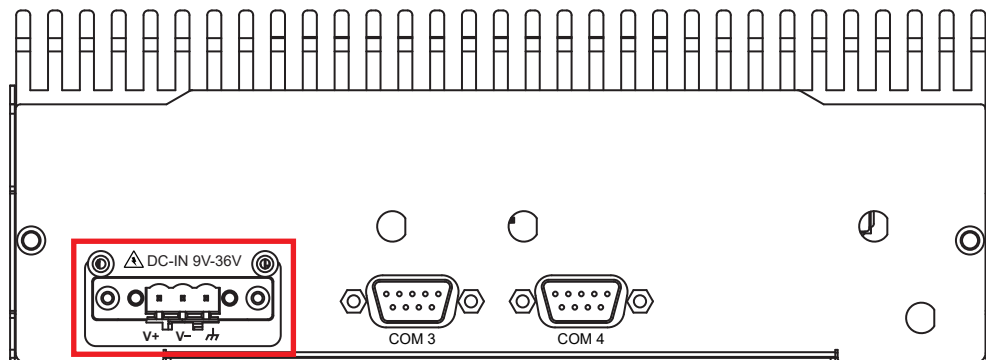

SPC-5600A system only supports 9V-36V DC power input by terminal block in the rear side. In normal power operation, power LED lightens in solid green.

Pin No.	Definition
1	V+
2	V-
3	Chassis Ground

### 2.3.2 Serial Port

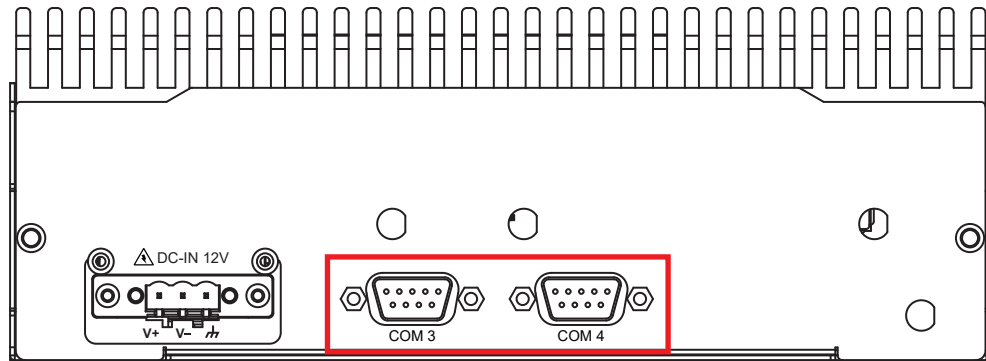

Serial port 3 to 4 (COM 3 to 4) can be configured for RS-232, RS-422, or RS-485 with auto flow control communication. The default definition of COM 3 and COM 4 is RS-232, if you want to change to RS-422 or RS-485, you can find the setting in BIOS.

BIOS Setting	Function
COM 3 COM 4	RS-232
	RS-422 (5-wire)
	RS-422 (9-wire)
	RS-485
	RS-485 w/z auto-flow control

The pin assignments are listed in the following table :

Serial Port	Pin No.	RS-232	RS-422 (5-wire)	RS-422 (9-wire)	RS-485 (3-wire)
3, 4	1	DCD	TXD-	TXD-	DATA-
	2	RXD	TXD+	TXD+	DATA+
	3	TXD	RXD+	RXD+	-----
	4	DTR	RXD-	RXD-	-----
	5	GND	GND	GND	GND
	6	DSR	-----	RTS-	-----
	7	RTS	-----	RTS+	-----
	8	CTS	-----	CTS+	-----
	9	RI	-----	CTS-	-----



## 2.4 Connector/Jumper Locations

### 2.4.1 Top View (Component Side) of EXBC-1000 Main Board With Connector Location

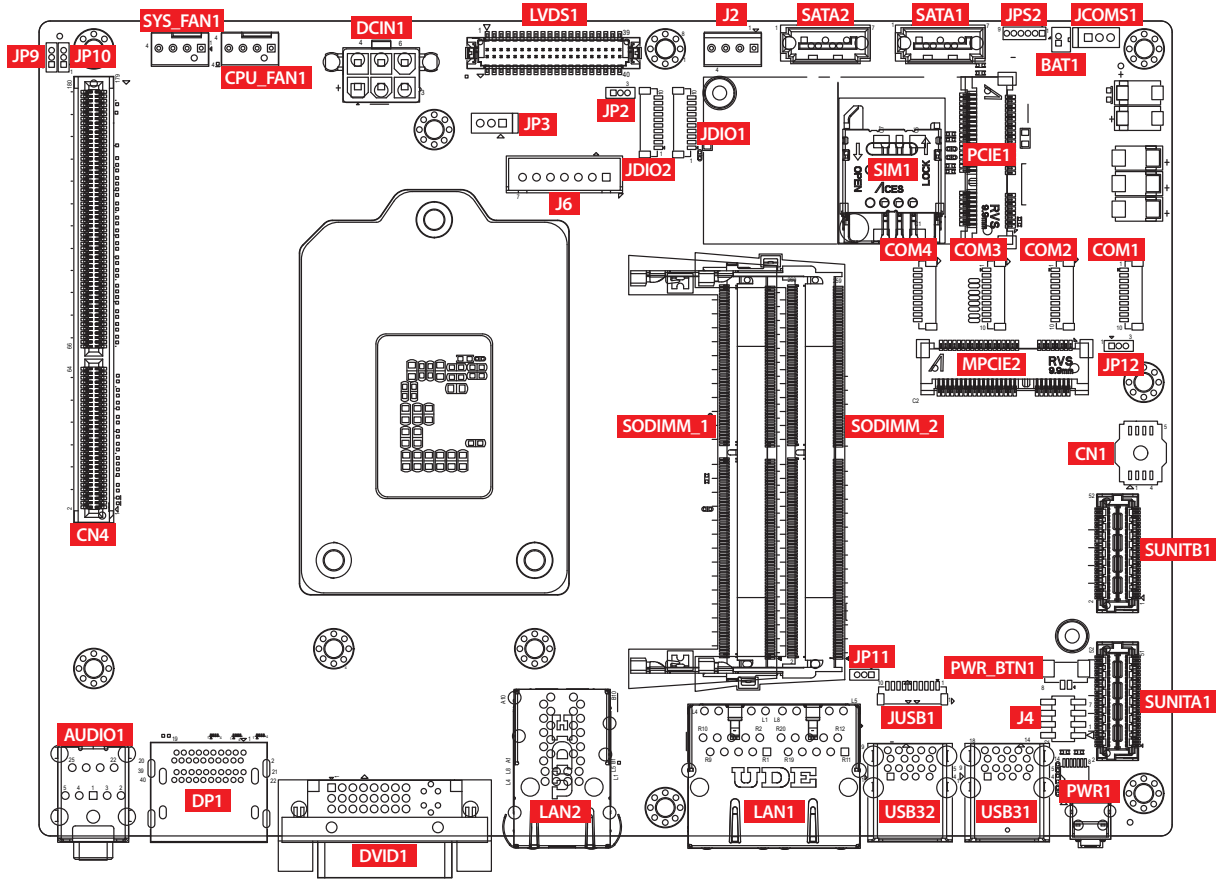

## 2.4.2 J4 : Miscellaneous Pin Header

These pin headers can be used as a backup for the following functions : hard drive, LED indicator, reset button, power LED indicator, and power on/off buttons, which already can be accessed by front panel and top panel. The pinouts of Miscellaneous port are listed in following table :

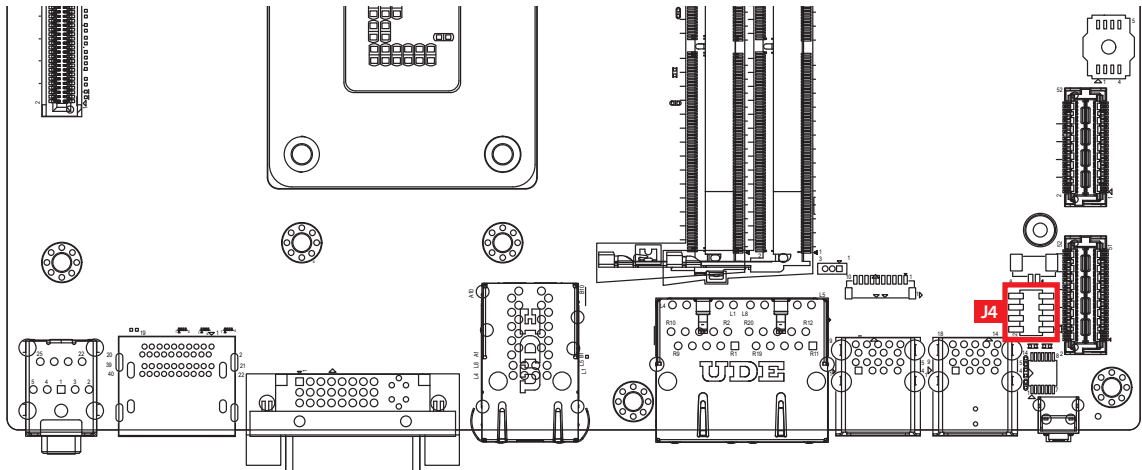

	Group	Pin No.	Description
	HDD LED	1	HDD_LED_P
		3	HDD_LED_N
	RESET BUTTON	5	FP_RST_BTN_N
		7	Ground
	POWER LED	2	PWR_LED_P
		4	PWR_LED_N
	POWER BUTTON	6	PWR_BTN_P
		8	Ground

## 2.4.3 SATA1, SATA2 : SATA III Connector

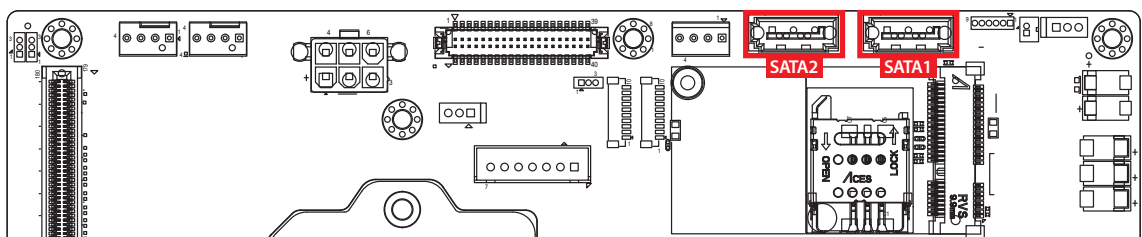

There are 2 onboard high performance Serial ATA III (SATA III) on EXBC-1000. It supports higher storage capacity with less cabling effort and smaller required space. The pin assignments of SATA1 and SATA2 are listed in the following table :

	Pin No.	Definition	Pin No.	Definition
	1	GND	2	TXP
	3	TXN	4	GND
	5	RXN	6	RXP
	7	GND		

## 2.4.4 J2 : SATA Power Connector

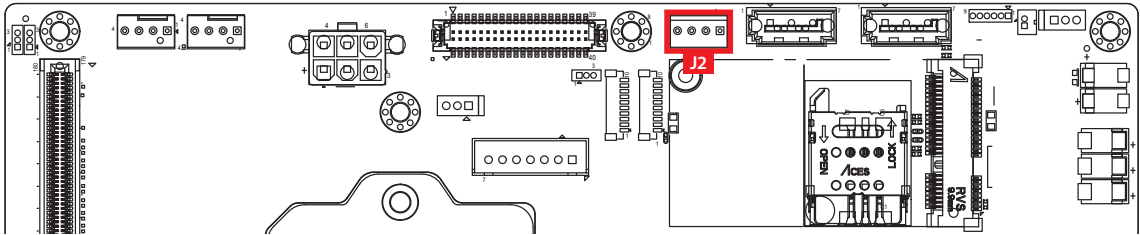

EXBC-1000 is also equipped with one SATA power connector. It supports 5V (Up to 2A) and 12V (Up to 1A) current to the hard drive or SSD. The pin assignments of J2 is listed in the following table :

	Pin No.	Definition	Pin No.	Definition
	1	+12V	2	GND
3	GND	4	+5V	

## 2.4.5 JUSB1 : Internal USB 2.0 Connector

The EXBC-1000 main board provides maxima eight expansion USB ports. The USB interface supports 480Mbps transfer rate which comply with high speed USB specification Rev. 2.0.

The USB interface is accessed through one 10-pin JST 1.0mm connector. You will need an adapter cable if you use a standard USB connector. The adapter cable has a 10-pin connector on one end and a USB connector on the other.

The pin assignments of JUSB1 are listed in the following table :

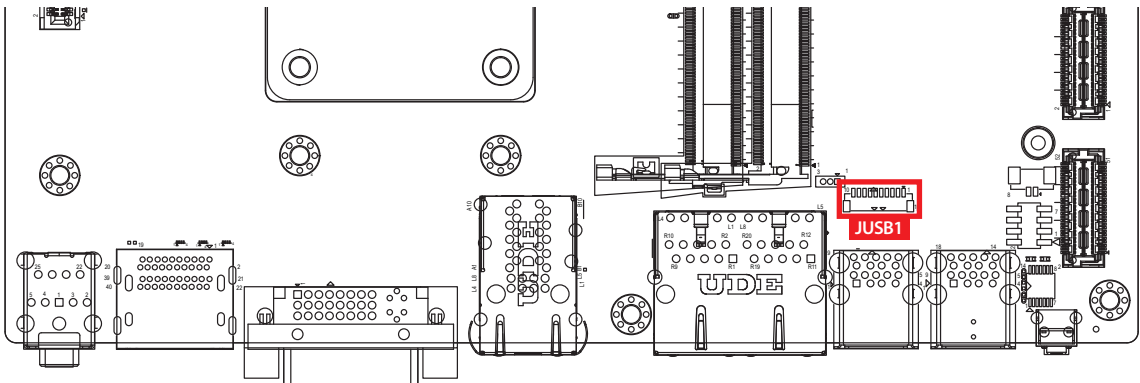

	Pin No.	Definition	Pin No.	Definition
	1	USB_VCC	2	USB_VCC
	3	USB_VCC	4	USB1-
	5	USB1+	6	USB2-
	7	USB2+	8	GND
	9	GND	10	GND

## 2.4.6 BAT1 : RTC Battery

The EXBC-1000's real-time clock is powered by a lithium battery. It is recommended that you don't replace the lithium battery on your own, but if the battery needs to be changed, please contact the Vecow RMA service team.

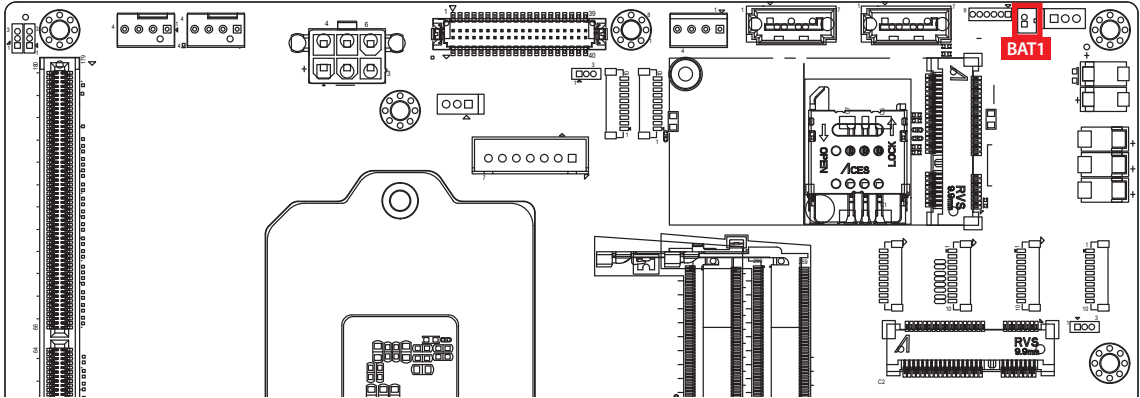

## 2.4.7 PWR\_BTN1 : Remote ON/OFF Connector

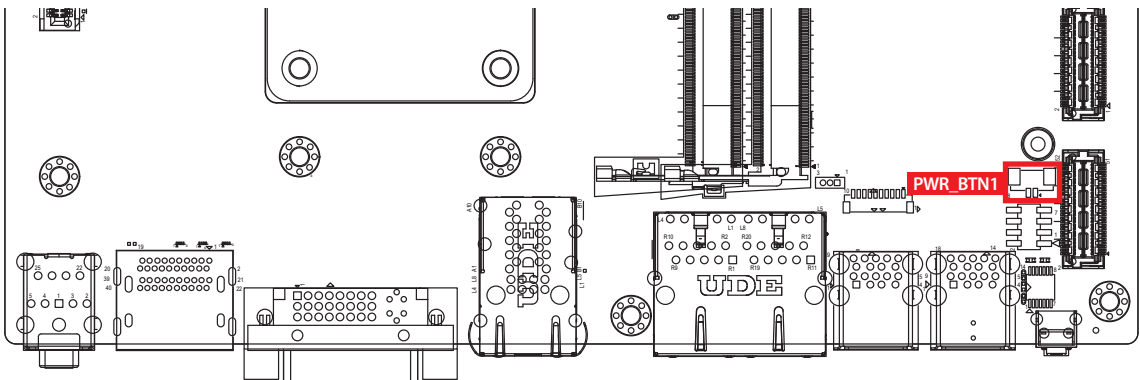

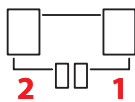
	Pin No.	Description
	1	PWR_BTN_P
	2	GND

## 2.4.8 MPCIE2 : Mini PCIe, mSATA

Both mSATA and Mini PCIe share the same form factor and similar electrical pinout assignments on their connectors. There was no clear mechanism to distinguish if a mSATA drive or a Mini PCIe device is plugged into the socket until recently that SATA I/O issued an ECN change (ECN #045) to redefine pin43 on mSATA connector as "no connect" instead of "return current path" (or GND).

When an mSATA drive is inserted, its pin-43 is "no connect", and the respective pin on the socket is being pulled-up to logic 1. When a Mini PCIe device is inserted, its pin-43 forces the respective pin on the socket to ground, or logic 0.

The pin assignments of MPCIE2 are listed in the following table :

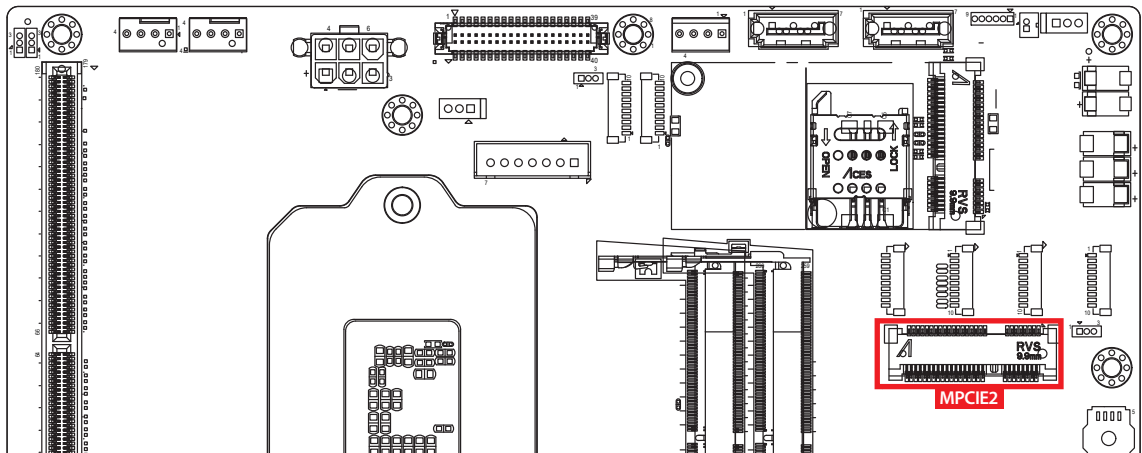

Pin No.	Signal Name	Pin No.	Signal Name
51	Reserved	52	+3.3Vaux
49	Reserved	50	GND
47	Reserved	48	+1.5V
45	Reserved	46	Reserved
43	SATA_PCIE_SEL	44	Reserved
41	+3.3Vaux	42	Reserved
39	+3.3Vaux	40	GND
37	GND	38	USB_D+
35	GND	36	USB_D-
33	PETp0	34	GND
31	PETn0	32	SMB_DATA
29	GND	30	SMB_CLK
27	GND	28	+1.5V
25	PERp0	26	GND
23	PERn0	24	+3.3Vaux
21	GND	22	PERST#
19	Reserved	20	reserved
17	Reserved	18	GND
Mechanical Key			

Pin No.	Signal Name	Pin No.	Signal Name
15	GND	16	Reserved
13	REFCLK+	14	Reserved
11	REFCLK-	12	Reserved
9	GND	10	Reserved
7	CLKREQ#	8	Reserved
5	Reserved	6	1.5V
3	Reserved	4	GND
1	WAKE#	2	3.3Vaux

## 2.4.9 MPCIE1 : Mini PCIe, SIM

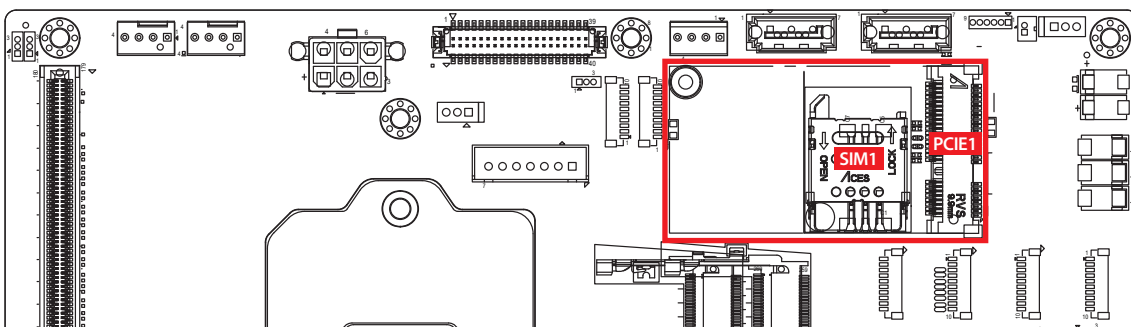

Pin No.	Signal Name	Pin No.	Signal Name
51	Reserved	52	+3.3Vaux
49	Reserved	50	GND
47	Reserved	48	+1.5V
45	Reserved	46	Reserved
43	GND	44	Reserved
41	+3.3Vaux	42	Reserved
39	+3.3Vaux	40	GND
37	GND	38	USB_D+
35	GND	36	USB_D-
33	PETp0	34	GND
31	PETn0	32	SMB_DATA
29	GND	30	SMB_CLK
27	GND	28	+1.5V
25	PERp0	26	GND
23	PERn0	24	+3.3Vaux
21	GND	22	PERST#
19	Reserved	20	reserved
17	Reserved	18	GND
Mechanical Key			

Pin No.	Signal Name	Pin No.	Signal Name
15	GND	16	UIM_VPP
13	REFCLK+	14	UIM_RESET
11	REFCLK-	12	UIM_CLK
9	GND	10	UIM_DATA
7	CLKREQ#	8	UIM_PWR
5	Reserved	6	1.5V
3	Reserved	4	GND
1	WAKE#	2	3.3Vaux

Note : The SIM card sockets do not support hot-plug. Please make sure to unplug the system power before inserting the SIM card(s).

## 2.4.10 COM1~COM4 : Serial Port

Serial port 1 to 4 (COM1 to 4) can be configured for RS-232, RS-422, or RS-485 with auto flow control communication. The default definition of COM1 and COM2 is RS-232, if you want to change to RS-422 or RS-485, you can find the setting in BIOS.

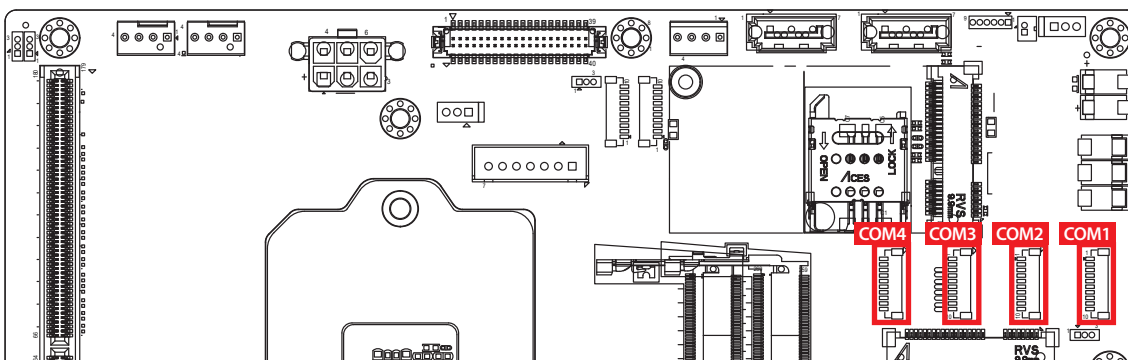

BIOS Setting	Function
COM1 COM2 COM3 COM4	RS-232
	RS-422 (5-wire)
	RS-422 (9-wire)
	RS-485
	RS-485 w/z auto-flow control

The pin assignments are listed in the following table :

Serial Port	Pin No.	RS-232	RS-422 (5-wire)	RS-422 (9-wire)	RS-485 (3-wire)
1, 2 3, 4	1	DCD	TXD-	TXD-	DATA-
	2	RXD	TXD+	TXD+	DATA+
	3	TXD	RXD+	RXD+	-----
	4	DTR	RXD-	RXD-	-----
	5	GND	GND	GND	GND
	6	DSR	-----	RTS-	-----
	7	RTS	-----	RTS+	-----
	8	CTS	-----	CTS+	-----
	9	RI	-----	CTS-	-----

COM1 to COM4 MB connector table :

COM Port	MB Connector	COM Port	MB Connector
COM1	COM1	COM2	COM2
COM3	COM3	COM4	COM4

CN	Pin No.	Signal Name
COM1 to 4	1	NC
	2	GND
	3	RI
	4	DTR
	5	CTS
	6	TXD
	7	RTS
	8	RXD
	9	DSR
	10	DCD

### 2.4.11 JDIO1~JDIO2 : GPIO Connector

There is a 16-bit GPIO connector on the top side. Each GPIO channel can be configuration GPI or GPO. Detail setting see APPENDIX. JDIO1 and JDIO2 Pin define are as below.

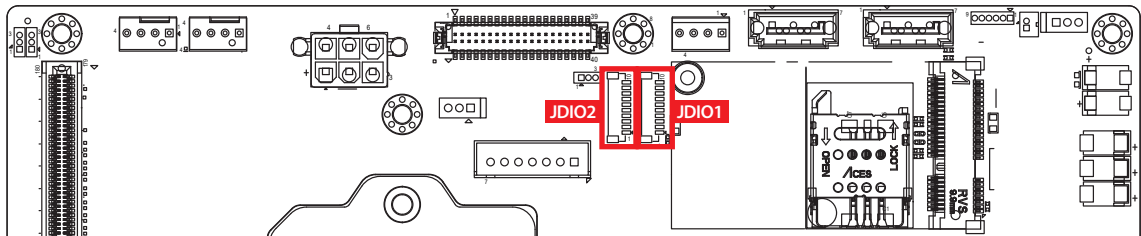

Pin No.	JDIO1 Definition	JDIO2 Definition
1	SIO_GPO70	SIO_GPI80
2	SIO_GPO71	SIO_GPI81
3	SIO_GPO72	SIO_GPI82
4	SIO_GPO73	SIO_GPI83
5	SIO_GPO74	SIO_GPI84
6	SIO_GPO75	SIO_GPI85
7	SIO_GPO76	SIO_GPI86
8	SIO_GPO77	SIO_GPI87
9	+3.3V	+3.3V
10	GND	GND

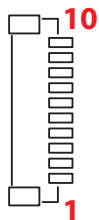



## 2.4.12 LVDS1, J6 : LVDS

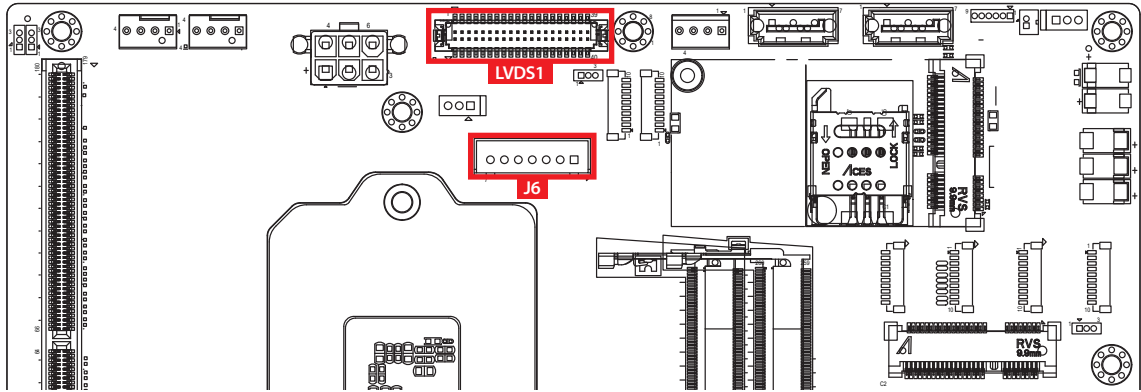

EXBC-1000 supports dual-channel 24-bit LVDS display and up to 1920 x 1200 pixels resolution. The pin assignments of LVDS are listed in the following table :

Pin No.	Definition	Pin No.	Definition
1	PANEL_VDD	2	TX00-
3	PANEL_VDD	4	TX00+
5	PANEL_VDD	6	TX01-
7	GND	8	TX01+
9	GND	10	TX02-
11	GND	12	TX02+
13	GND	14	TX0C-
15	GND	16	TX0C+
17	GND	18	TX03-
19	GND	20	TX03+
21	GND	22	TXE0-
23	GND	24	TXE0+
25	GND	26	TXE1-
27	GND	28	TXE1+
29	GND	30	TXE2-
31	GND	32	TXE2+
33	GND	34	TXEC-
35	GND	36	TXEC+
37	GND	38	TXE3-
39	LVDS_DET#	40	TXE3+

The LCD inverter is connected to J6 via a JST 7-pin, 2.5mm connector providing +5V/+12V power to LCD display. The pin assignments are listed in the following table :



Pin No.	Definition	Pin No.	Definition
1	+5V	2	+12V
3	+12V	4	LBKLT_CTL
5	GND	6	GND
7	LBKLT_EN		

### 2.4.13 JPS2 : PS/2 Mouse Keyboard Pin Head

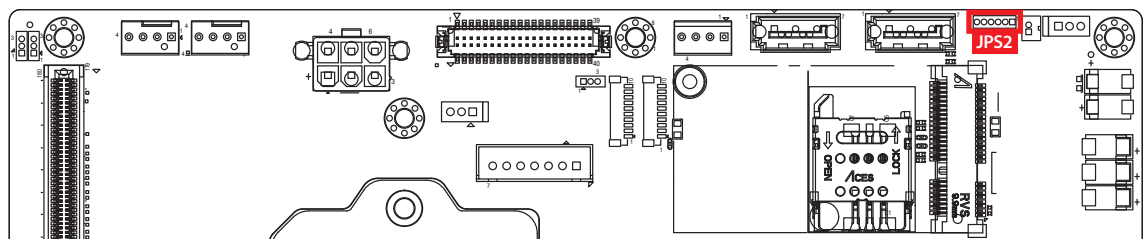
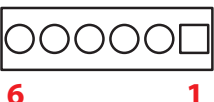

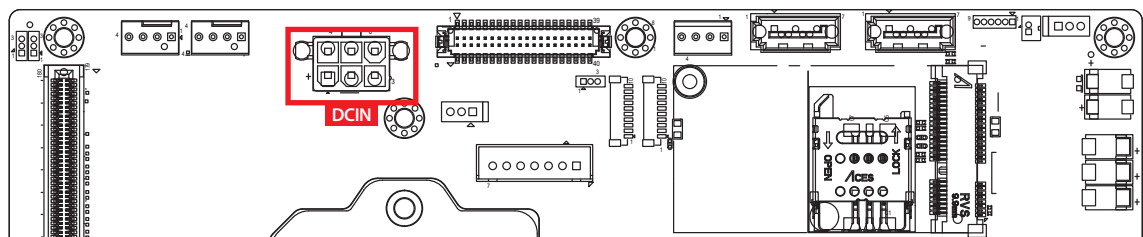

Pin No.	Definition	Pin No.	Definition
1	SIO_MCLK	2	SIO_MDAT
3	GND	4	SIO_KCLK
5	SIO_KDAT	6	VCC5_KBMS

### 2.4.14 DCIN1 : DC INPUT Power Connector

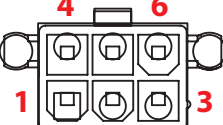

EXBC-1000 supports 12V DC power input by wire-to-board connector on the top side.



Pin No.	Definition	Pin No.	Definition
1	+12V	2	+12V
3	+12V	4	GND
5	GND	6	GND

## 2.4.15 CPU\_FAN1, SYS\_FAN1 : FAN Connector

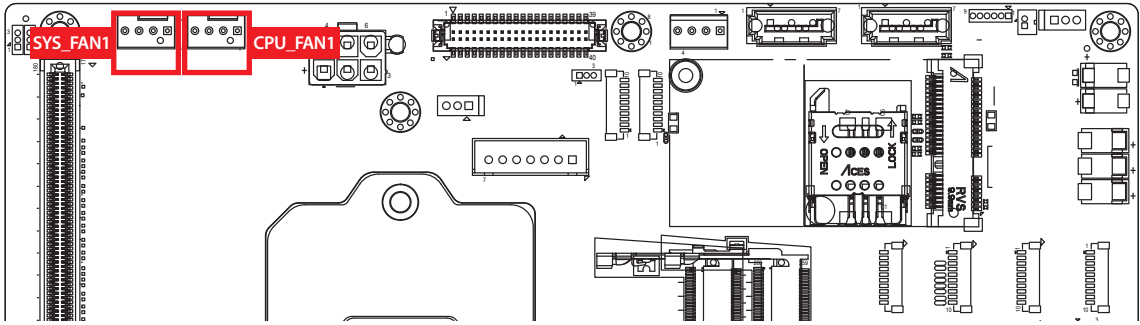

Fan connectors support for additional thermal requirement. The pin assignments of FAN are listed in the following table.

		Pin No.	Definition	Pin No.	Definition
		1	GND	2	+12V (1.5A max)
3	Fan speed sensor	4	Fan PWM		

## 2.4.16 CN4 : PCIe Riser Slot

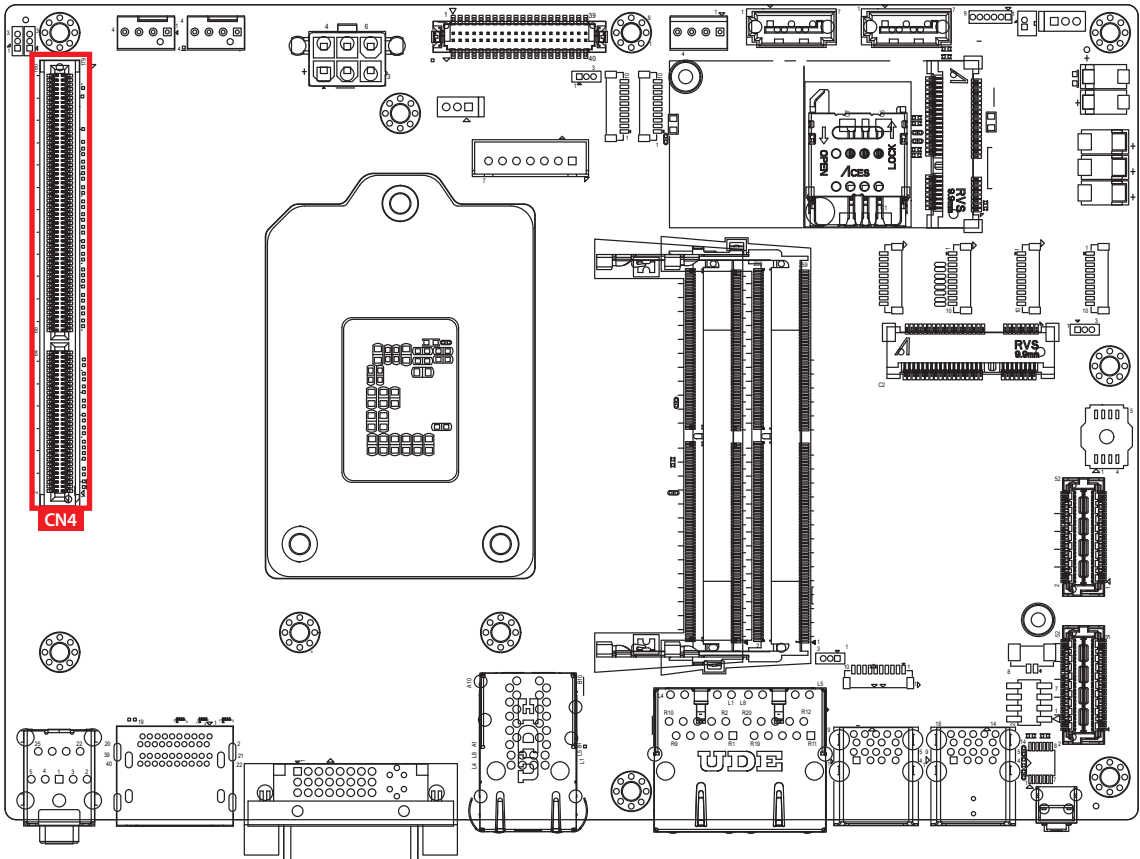

CN4 slot is used to connect with SPC-5000 AUX Backplane.

## 2.5 Jumper Settings

### 2.5.1 Front View of EXBC-1000 Main Board With Jumper Location

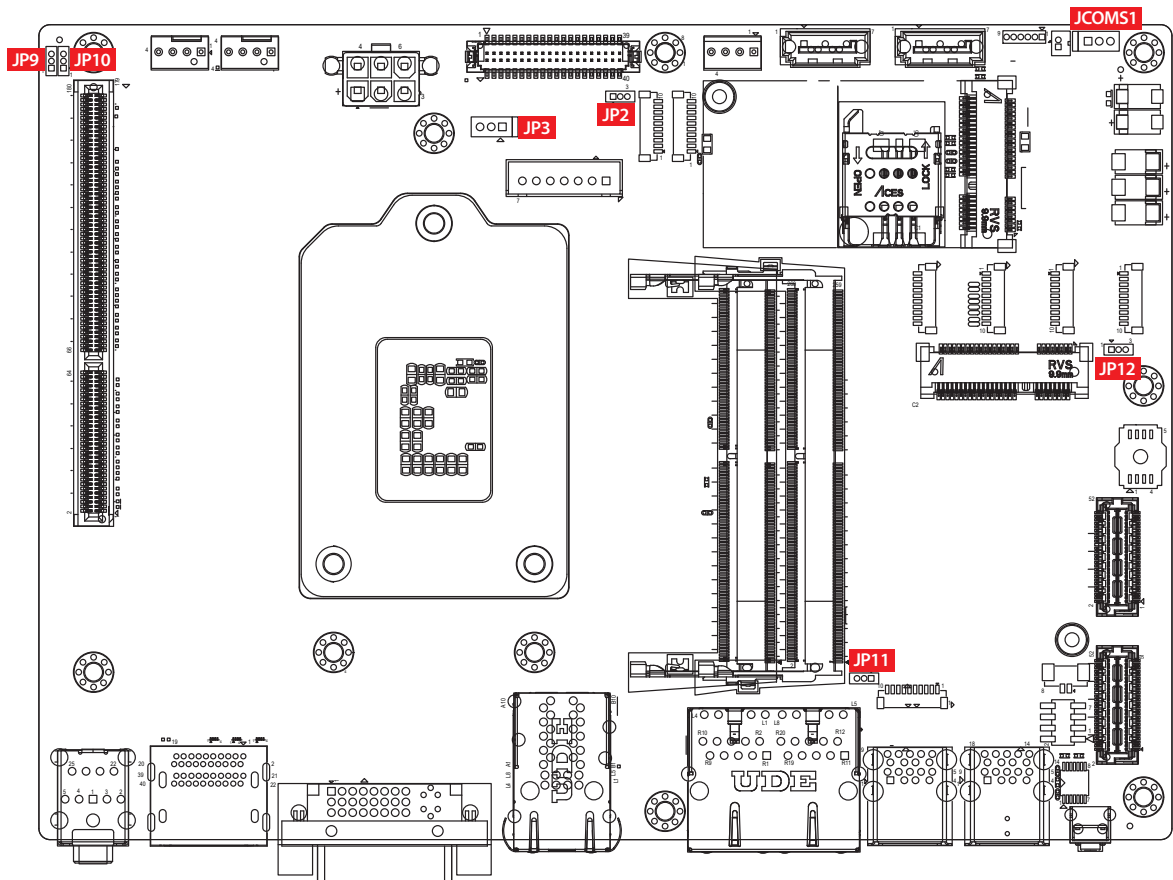

You may configure your card to match the needs of your application by setting jumpers. A jumper is a metal bridge used to close an electric circuit. It consists of two metal pins and a small metal clip (often protected by a plastic cover) that slides over the pins to connect them. To "close" a jumper, you connect the pins with the clip. To "open" a jumper, you remove the clip. Sometimes a jumper will have three pins, labeled 1, 2, and 3. In this case you would connect either pins 1 and 2, or 2 and 3.

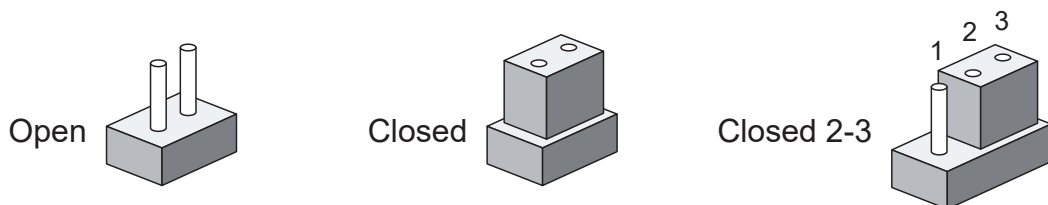

## 2.5.2 JP3 : LVDS Module, Power Selection

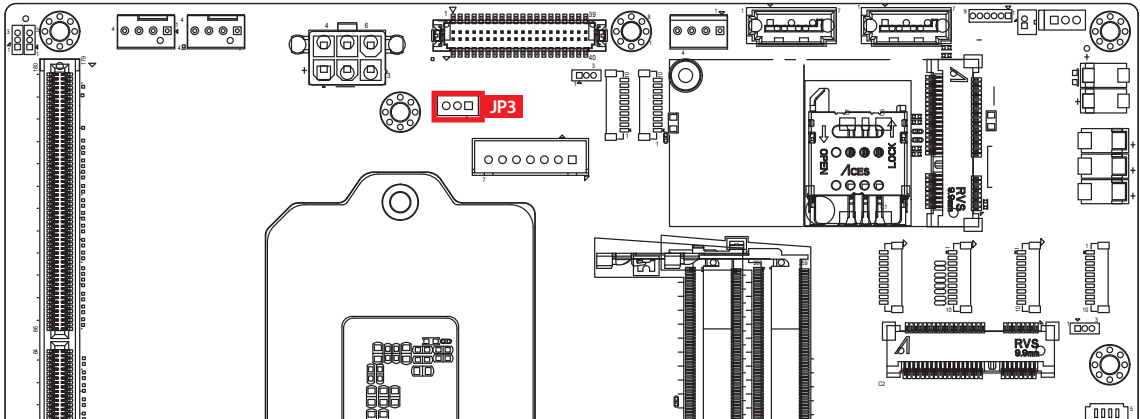

JP3 provides LVDS voltage selection function, Closing Pin 1 and Pin 2 is for 3.3V LVDS power input; closing Pin 2 and Pin 3 is for 5V LVDS power input.

	Pin No.	Definition
	1-2	+3.3V (Default)
	2-3	+5V

## 2.5.3 JCMOS1 : Clear CMOS

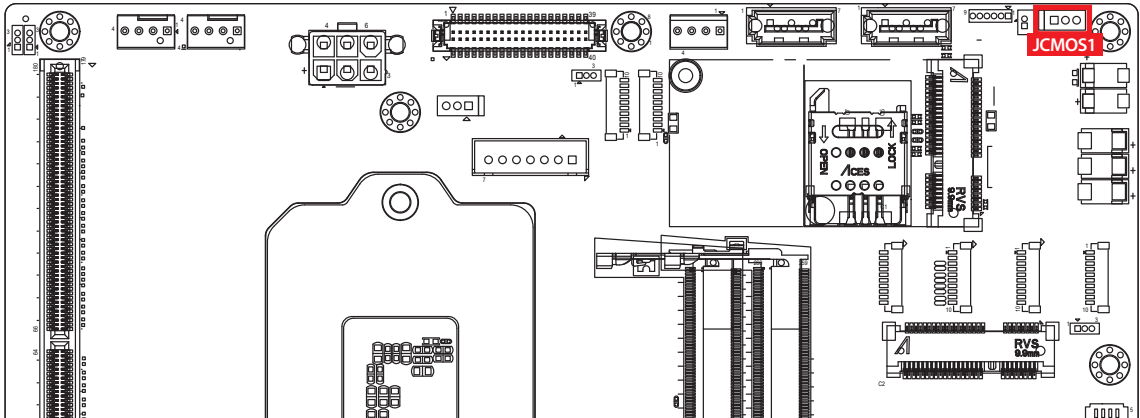

	CMOS	Header
	1-2	Normal
	2-3	Clear CMOS

## 2.5.4 JP11 : External USB 3.0/2.0 Power Select

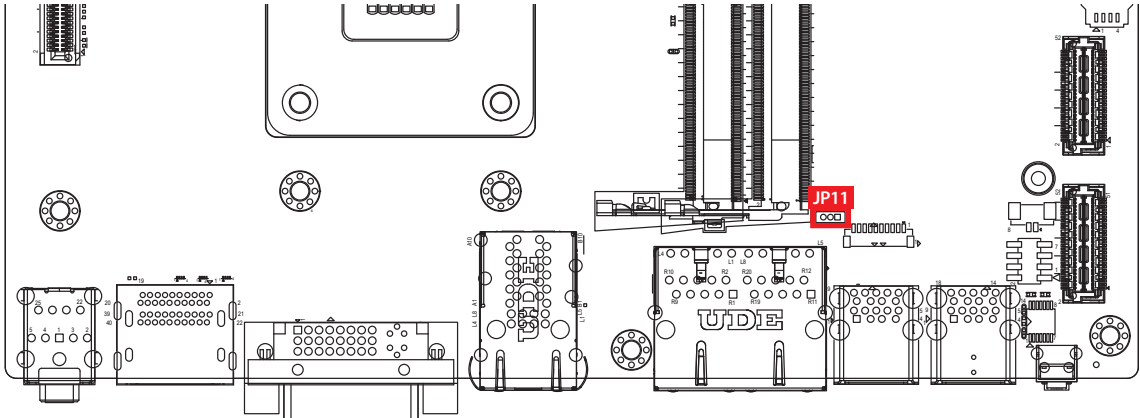

	Pin No.	Power
	1-2	+5V Standby Power
	2-3	+5V System Power

## 2.5.5 JP2 : Backlight Control Level Select

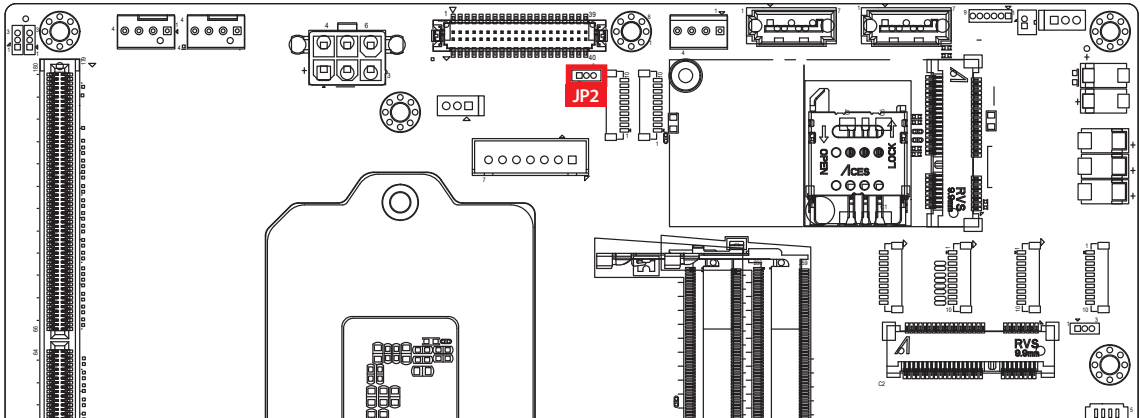

	Pin No.	Definition
	1-2	3.3V
	2-3	5V

## 2.5.6 JP12 : Mini PCIE mSATA, mPCIE Select

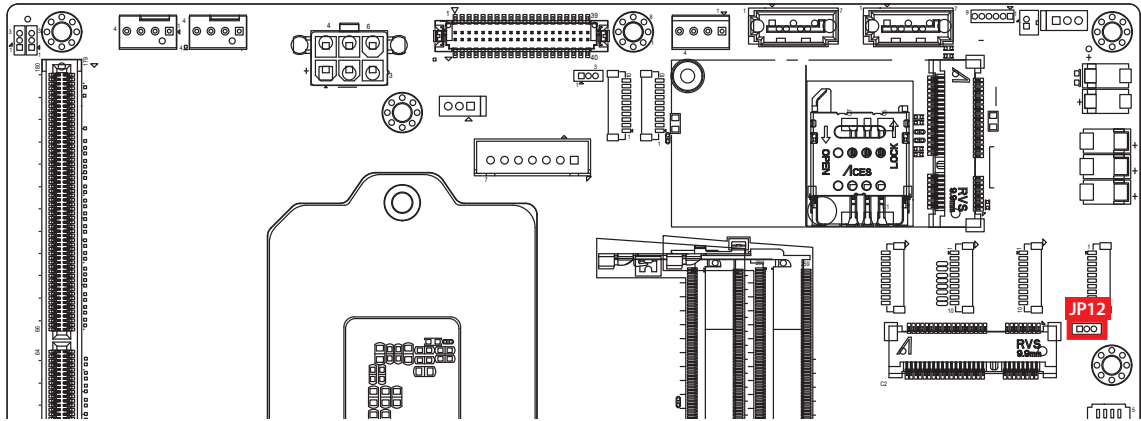

	Pin No.	Power
	1-2	Mini PCIE
	2-3	Auto
	OPEN	Mini SATA

## 2.5.7 JP9, JP10 : PCI Express\* Configuration

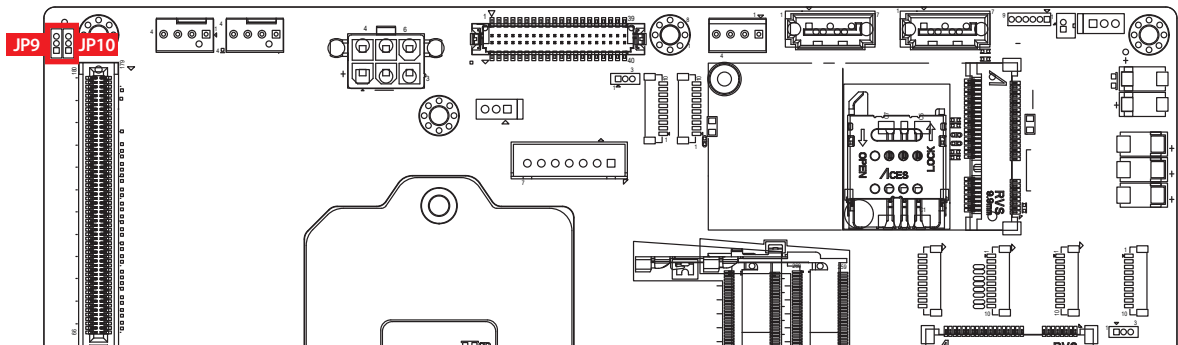

JP9, JP10 provide PCIe configuration function, Closing Pin 1 and Pin 2 is logic "0". Closing Pin 2 and Pin 3 is logic "1"

JP9, JP10 logic setting are listed in the following table.

	JP9	Logic
	1-2	0
	2-3	1

	JP10	Logic
	1-2	0
	2-3	1

JP9, JP10 PCI Express configurations are listed in the following table.

JP10	JP9	PCI Express* Bifurcation
0	0	1 x8 PCI Express*
1	0	2 x8 PCI Express*
1	1	1 x16 PCI Express*

# 3

## SYSTEM SETUP

### 3.1 How to Open Your SPC-5600

**Step 1** Remove bottom five F#6-32 (red).

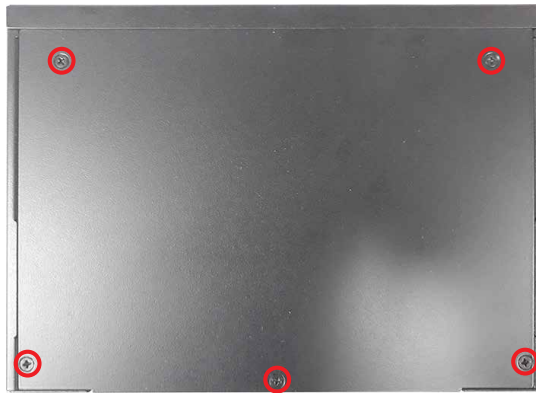

**Step 2** Open bottom cover.

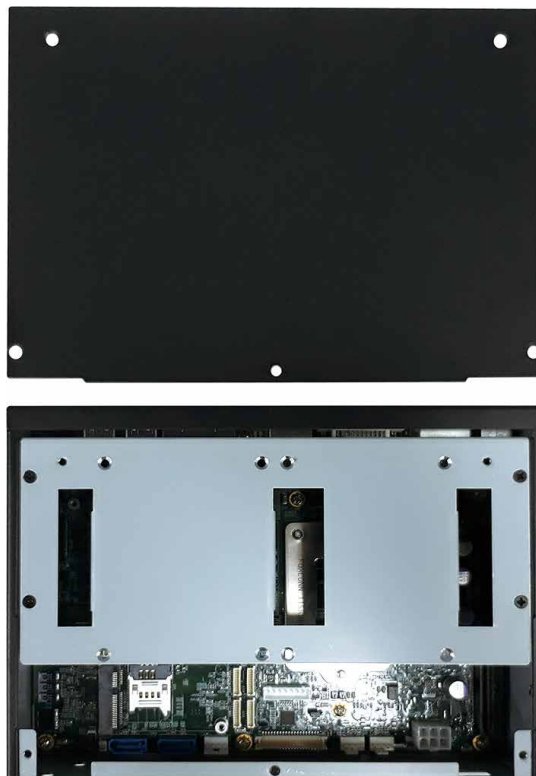



**Step 3** Remove hdd tray four F#6-32 (red).

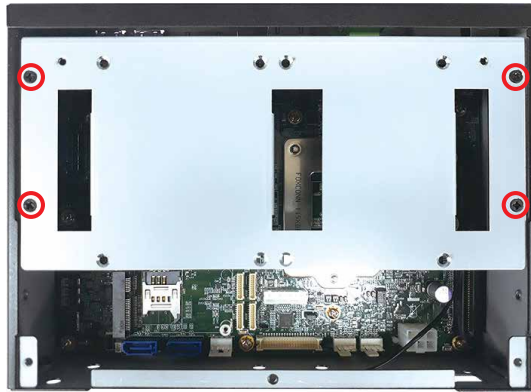

**Step 4** Remove hdd tray four F#6-32 (red).

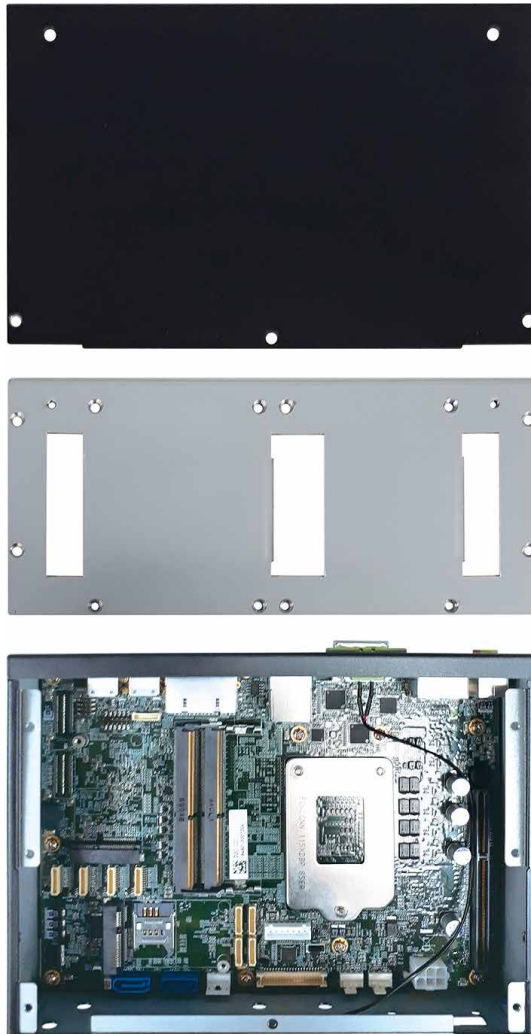

## 3.2 Installing CPU

**Step 1** Remove eleven PH-M3 screws and pick up mother board.

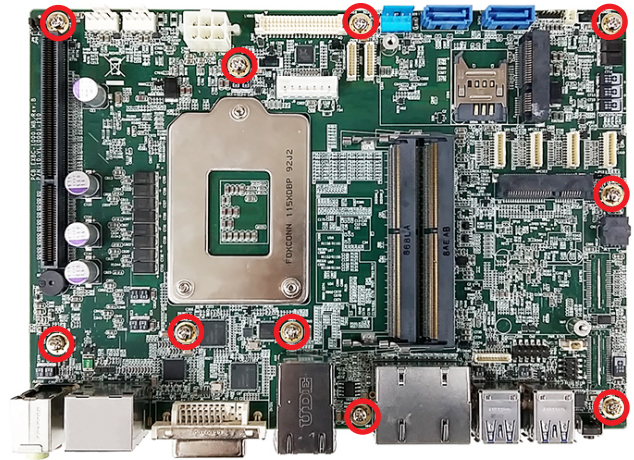

**Step 2** Open CPU Slot cover.



**Step 3** Install CPU into the CPU Slot.  
(Be careful CPU pin)

**Step 4** Close and lock CPU Slot cover.





### 3.3 Installing DDR4 SO-DIMM Modules

**Step 1** Install DDR4 RAM module into SO-DIMM slot.

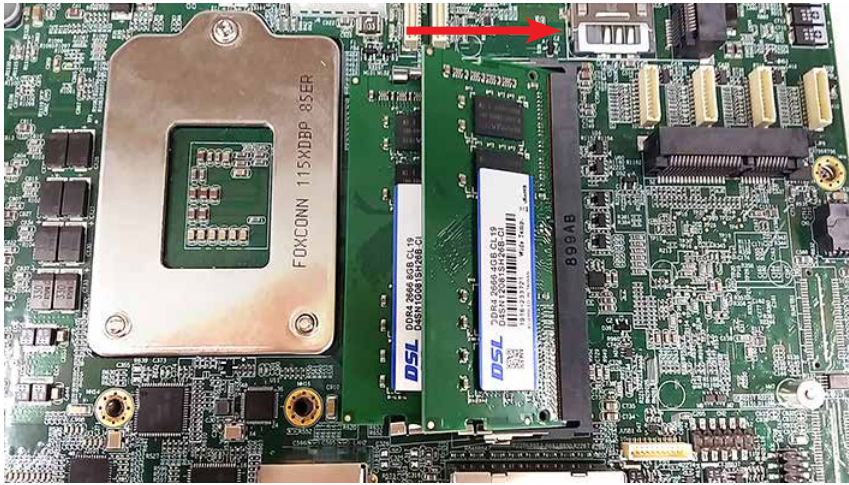

**Step 2** Make sure the RAM module is locked by the memory slot.

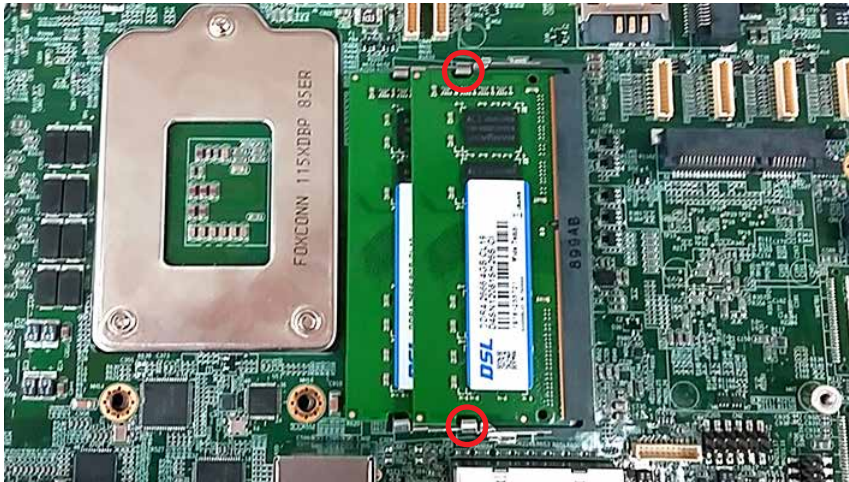

### 3.4 Installing Mini PCIe Card

**Step 1** Install Mini PCIe card into the Mini PCIe slot.



**Step 2** Fasten one M2.5 screw.



## 3.5 Installing Antenna Cable

**Step 1** Install Mini PCIe card into the Mini PCIe slot.



**Step 2** Put Antenna cable connector into the hole on rear panel and fasten the washer 1, washer 2 and washer 3 on Antenna cable connector.





## 3.6 Installing SIM Card

**Step 1** Open the SIM card cover.

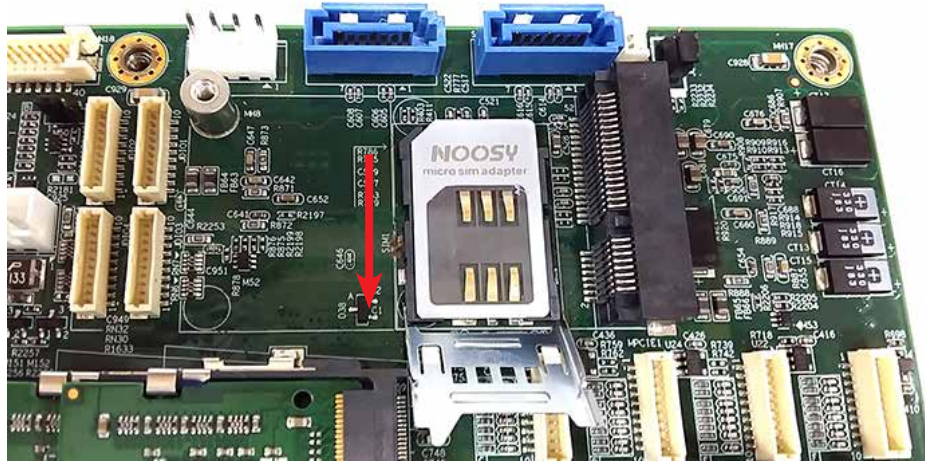

**Step 2** Install SIM card into the SIM card slot and then close and lock the SIM card cover.

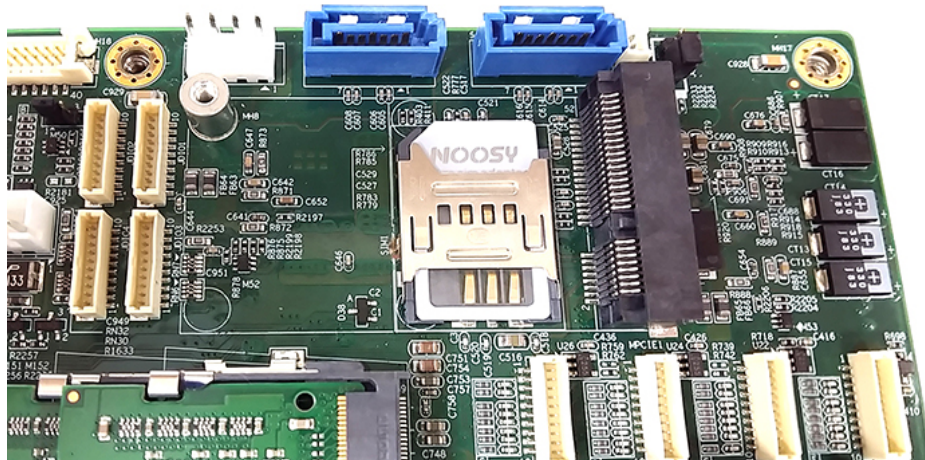

## 3.7 Installing SSD/HDD

### 3.7.1 Installing SSD/HDD of SPC-5600

**Step 1** Remove four F#6-32 (red).



**Step 2** Install SSD/HDD on HDD Tray  
Lock KH-M3 screw. (One SSD/HDD with four KH-M3 screws)

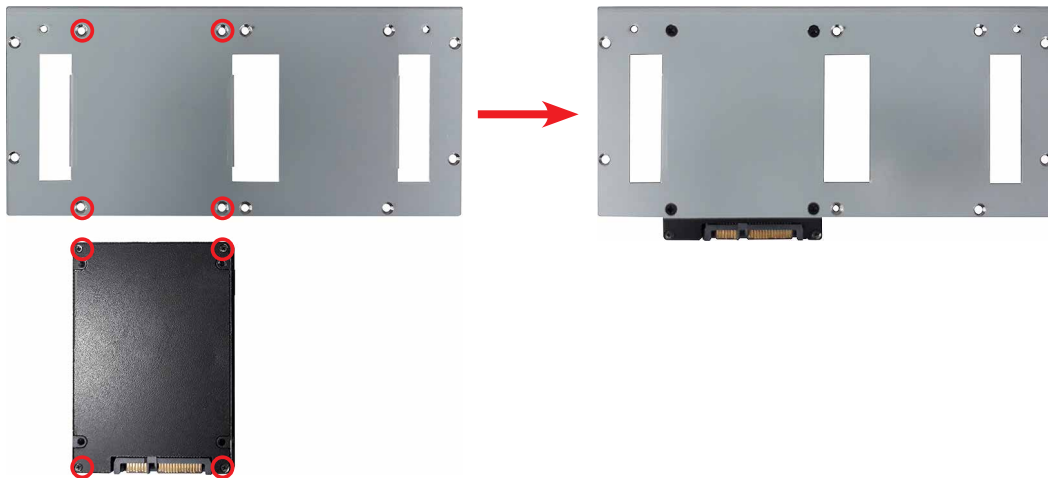

**Step 3** Installing power and SATA cable with SSD/HDD.



### 3.7.2 Installing SSD/HDD of SPC-5600A

**Step 1** Lock HDD BRACKET using KH-M3 screw.



**Step 2** Lock the Hdd bracket and Hdd tray using the KH-M3 screw.

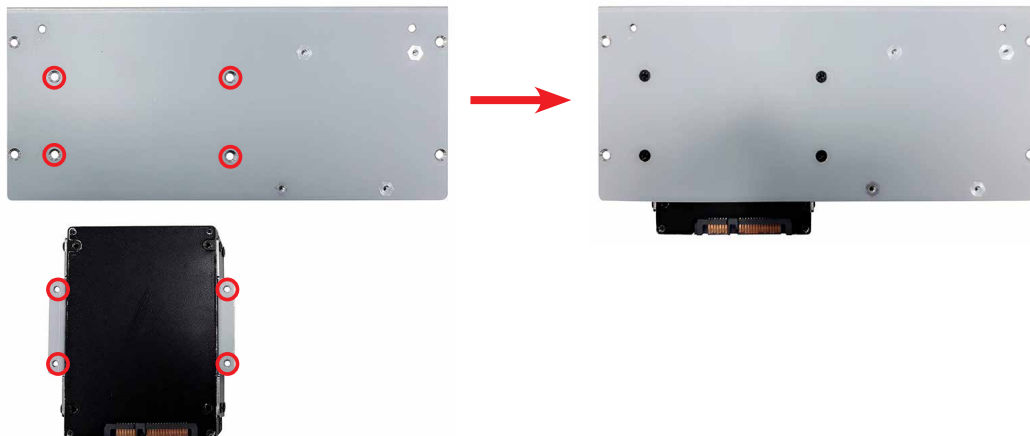

**Step 3** Lock Hdd tray using KH-M3 screw.





## 3.8 Installing Fan Bracket

**Step 1** Ensure the screw locations on fan bracket fit the ones on the heat sink.

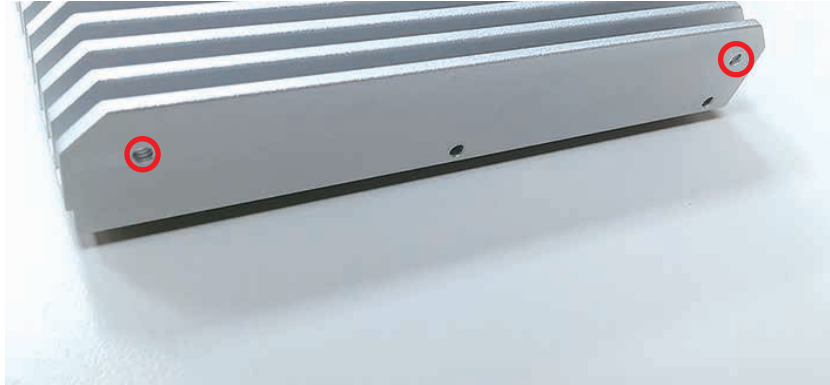

**Step 2** Put the fan cable into the sink gap as instructed.



**Step 3** Fasten four #6-32\*6L screws (circled in red).

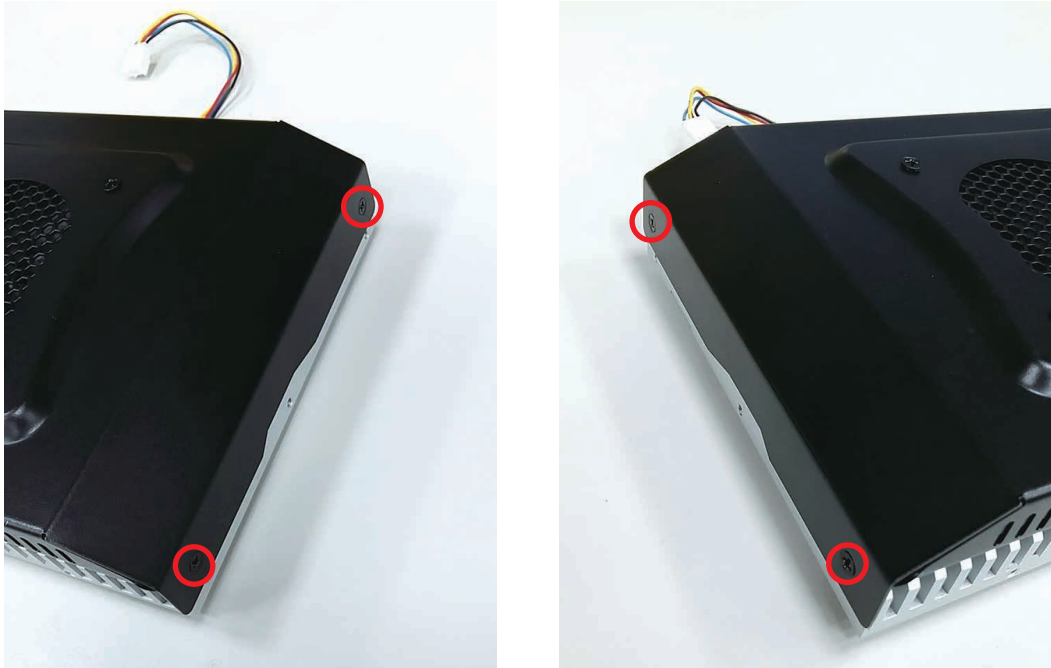

**Step 4** Finish.

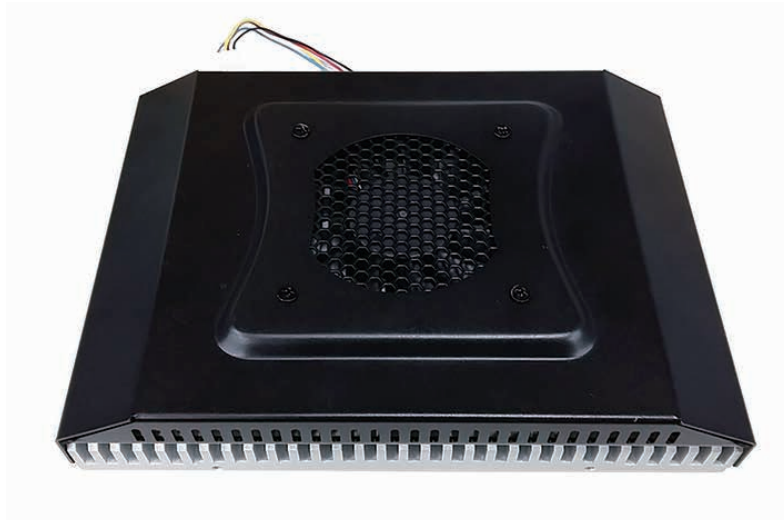

## 3.9 Mounting Your SPC-5600

### 3.9.1 Wall Mount Bracket

**Step 1** Ensure the screw holes on the right and left side of upper case match the ones on SPC-5600 wall mount bracket.

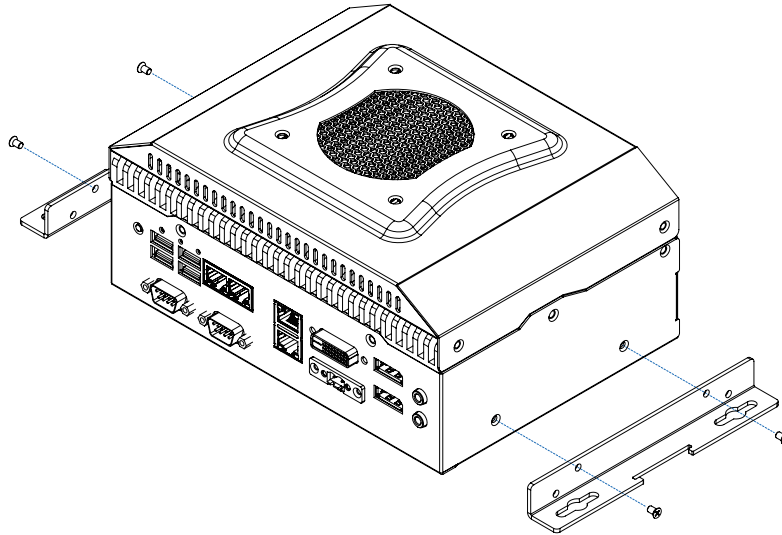

**Step 2** Fasten four #6-32 screws then finish.

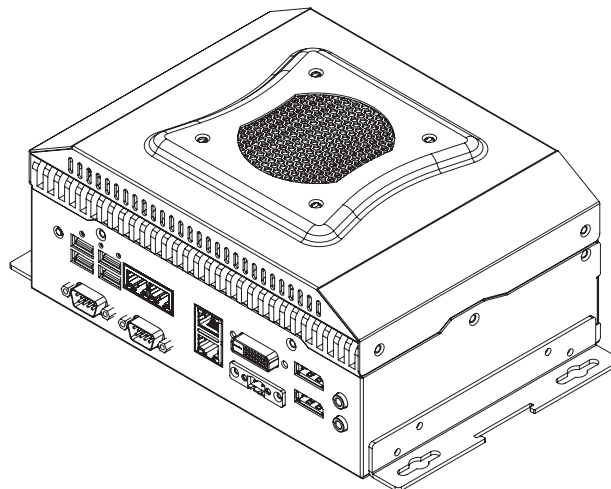

### 3.9.2 VESA Mount Bracket

**Step 1** Take SPC-5600 and VESA Mount with fasten four #6-32 screws.

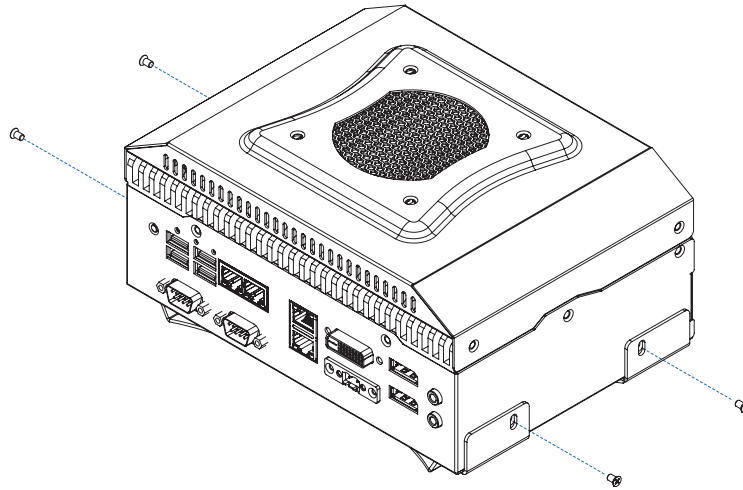

**Step 2** Fasten four #6-32 screws then finish.

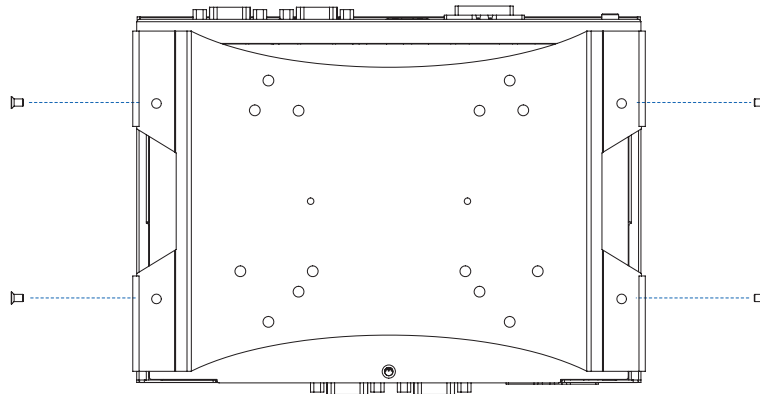

# 4

## BIOS SETUP

### 4.1 Entering BIOS Setup

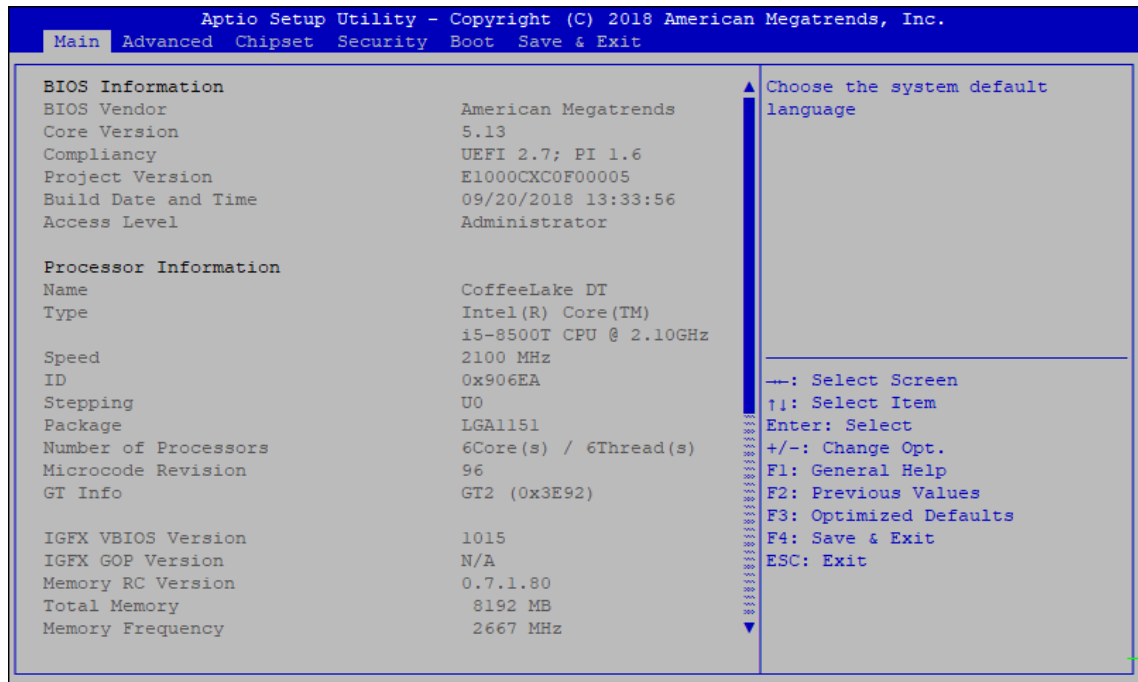

Figure 4-1 : Entering Setup Screen

BIOS provides an interface for users to check and change system configuration. The BIOS setup program is accessed by pressing the <Del> key when POST display output is shown.

## 4.2 Main

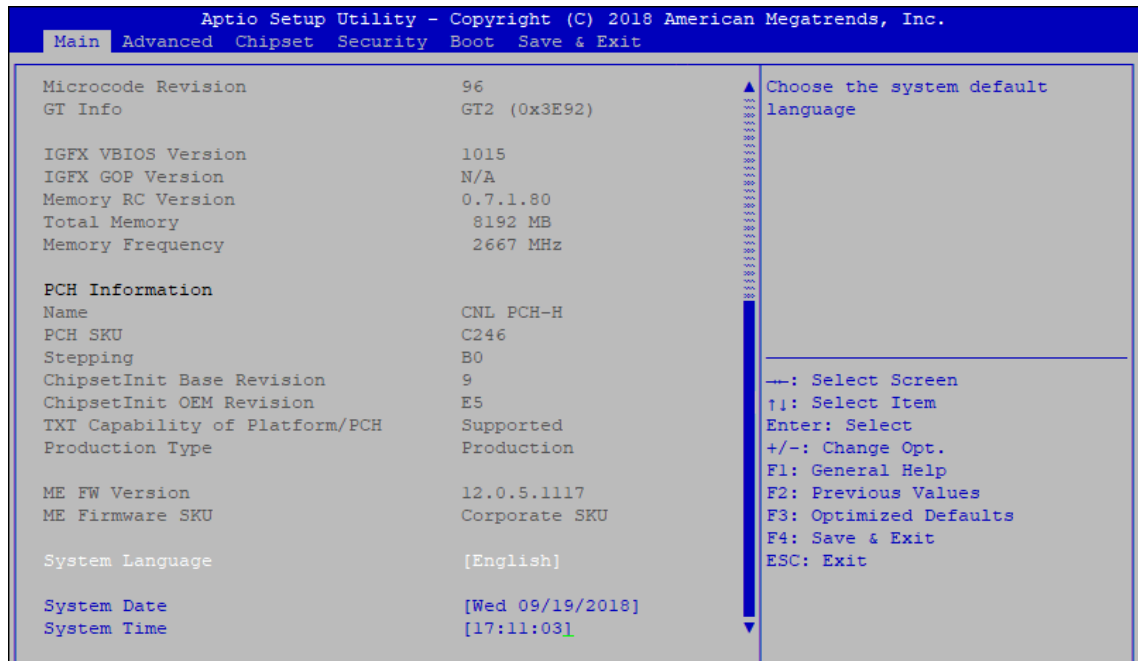

Figure 4-2 : BIOS Main Menu

The main menu displays BIOS version and system information. There are two options on Main menu.

### System Date

Set the date. Use <Tab> to switch between date elements.

### System Time

Set the time. Use <Tab> to switch between time elements.

## 4.3 Advanced

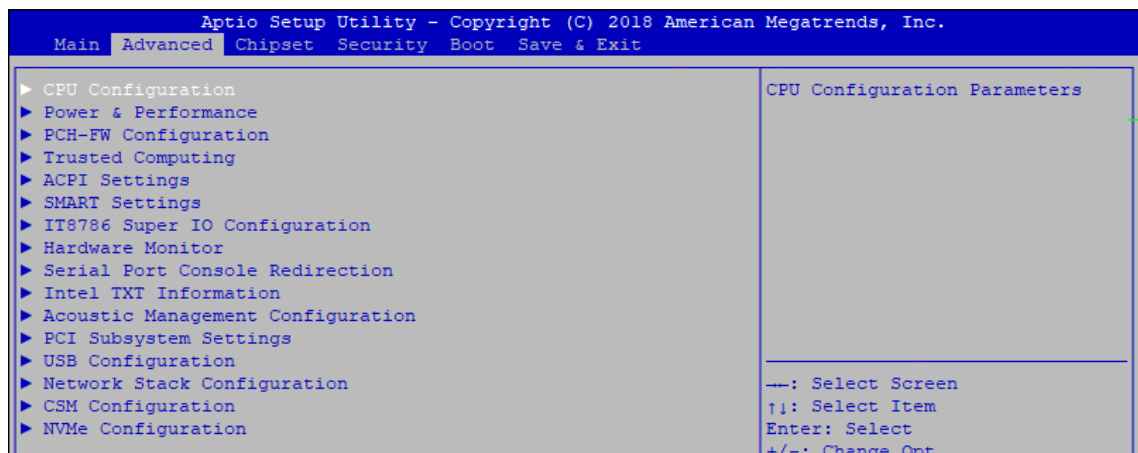

Figure 4-3 : BIOS Advanced Menu

Select advanced tab to enter advanced BIOS setup options, such as CPU configuration, SATA configuration, and USB configuration.

### 4.3.1 CPU Configuration

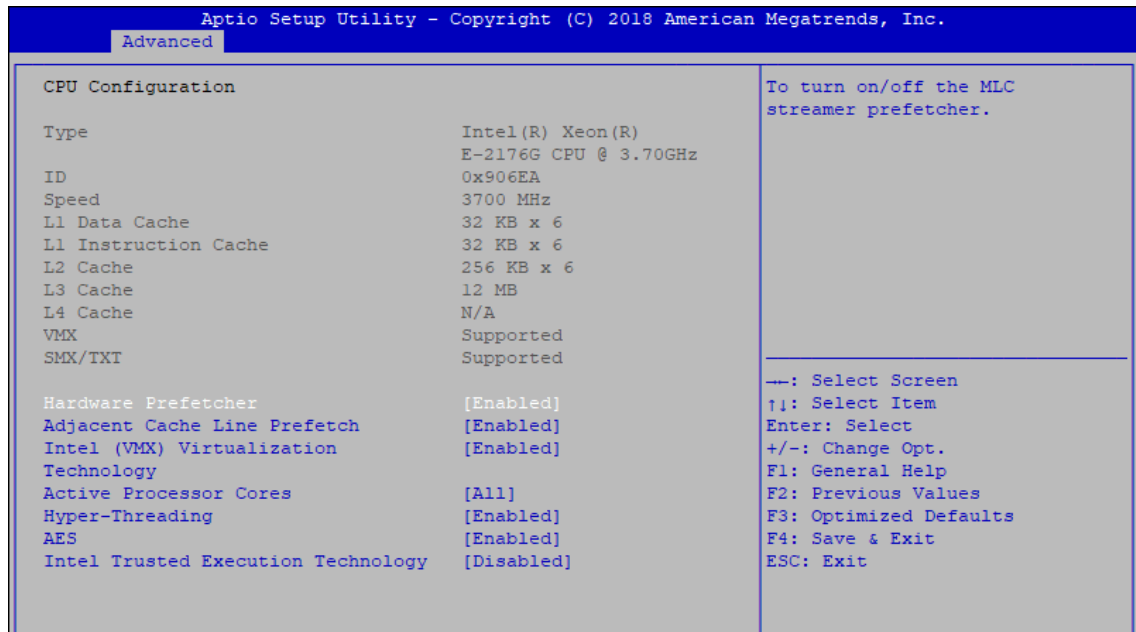

Figure 4-3-1 : CPU Configuration

#### Hardware Prefetcher

To turn on/off the MLC streamer prefetcher.

#### Adjacent Cache Line Prefetch

To turn on/off prefetching of adjacent cache lines.

#### Intel (VMX) Virtualization Technology

When enabled, a VMM can utilize the additional hardware capabilities provided by Vanderpool Technology.

#### Active Processor Cores

Number of cores to enable in each processor package.

#### Hyper-threading

Enabled for Windows XP and Linux (OS optimized for Hyper-Threading Technology) and disabled for other OS (OS not optimized for Hyper-Threading Technology). When disabled only one thread per core is enabled.

#### AES

Enable/disable CPU Advanced Encryption Standard instructions.

#### Intel Trusted Execution Technology

Enables utilization of additional hardware capabilities provided by Intel® Trusted Execution Technology.

Changes require a full power cycle to take effect.

## 4.3.2 Power & Performance

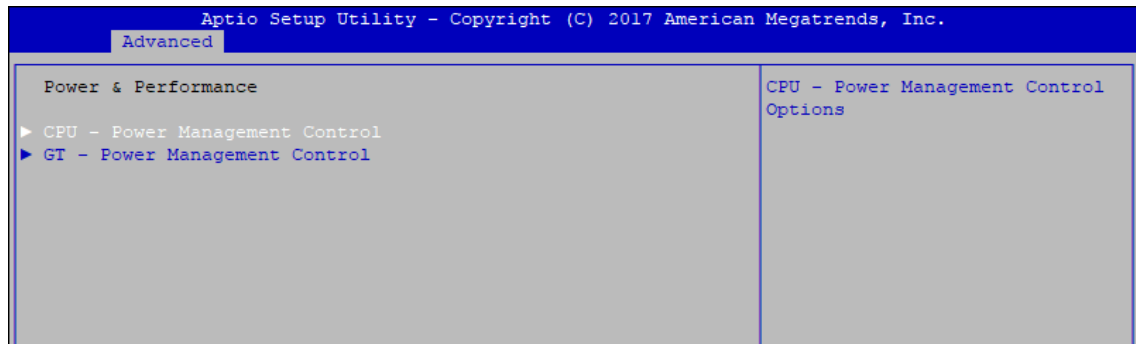

Figure 4-3-2 : Power & Performance

### 4.3.2.1 CPU – Power Management Control

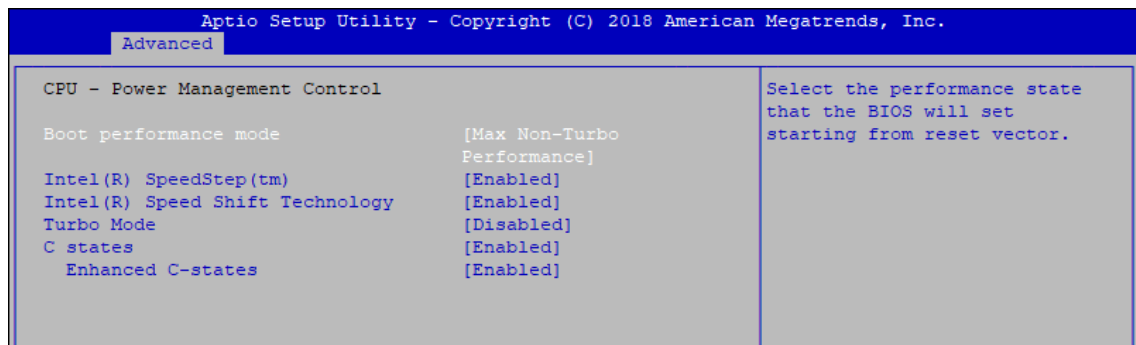

Figure 4-3-2-1 : CPU – Power Management Control

#### Boot performance mode

Select the performance state that the BIOS will set before OS handoff.

#### Intel(R) SpeedStep(tm)

Allows more than two frequency ranges to be supported.

#### Intel(R) Speed shift Technology

Enable/Disable Intel® Speed Shift Technology support. Enabling will expose the CPPCV2 interface to allow for hardware controlled P-states.

#### Turbo Mode

Turbo Mode.

#### C states

Enable or disable CPU C states.

#### Enhanced C-states

Enable/disable C1E. When enabled, CPU will switch to minimum speed when all cores enter C-State.



### 4.3.2.2 GT – Power Management Control

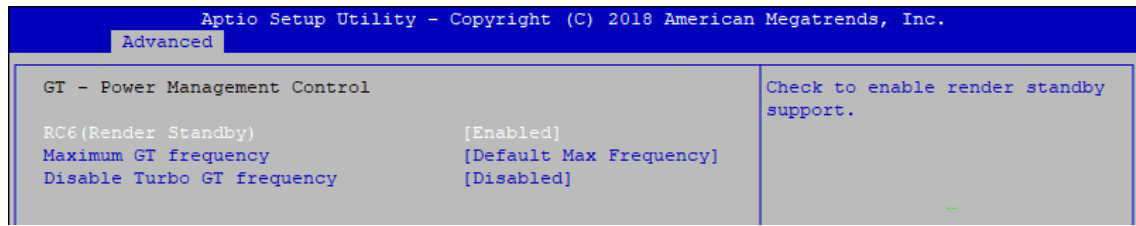

Figure 4-3-2-2 : GT – Power Management Control

#### RC6 (Render Standby)

Check to enable render standby support.

#### Maximum GT frequency

Maximum GT frequency limited by the user. Choose between 350MHz (RPN) and 1150MHz (RP0). Value beyond the range will be clopped to min/max supported by SKU.

#### Disable Turbo GT frequency

Check to enable render standby support.

### 4.3.3 PCH-FW Configuration



Figure 4-3-3 : PCH-FW Settings

#### ME State

Set ME to Soft temporarily disabled.

#### AMT BIOS Features

When disabled AMT BIOS Features are no longer supported and user is no longer able to access MEBx Setup.

#### AMT Configuration

Configure Intel® Active Management Technology Parameters.

#### ME Unconfig on RTC Clear State

Disabling this option will cause ME not to unconfigure on RTC clear.

### 4.3.4 Trusted Computing

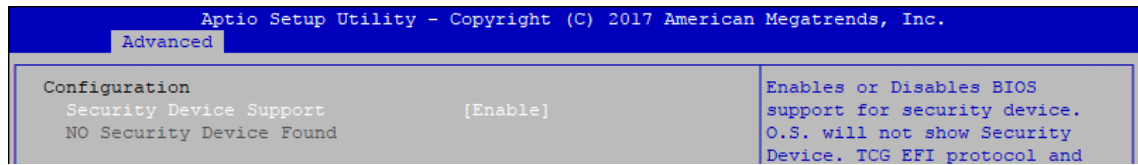

Figure 4-3-4 : Trusted Computing

Control the TPM device status and display related information if TPM chip is present.

### 4.3.5 ACPI Settings

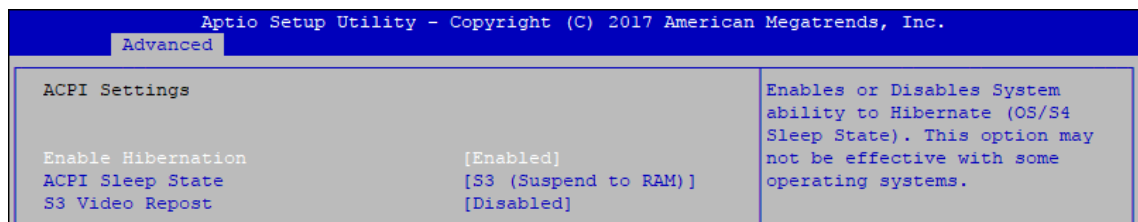

Figure 4-3-5 : ACPI Settings

#### Enable Hibernation

Enables or disables system's ability to hibernate (OS/S4 sleep state). This option may not be effective with some OS.

#### ACPI Sleep State

Selects the highest ACPI sleep state the system will enter when the SUSPEND button is pressed.

#### S3 Video Repost

Enables or disables S3 video repost.

### 4.3.6 SMART Settings

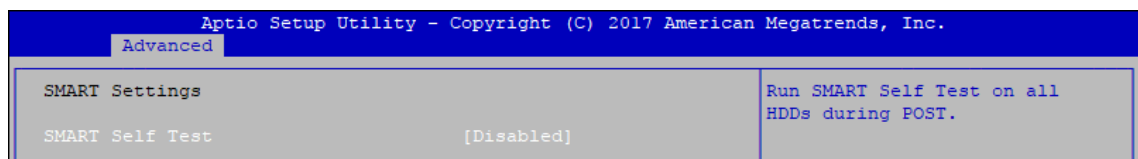

Figure 4-3-6 : SMART Settings

#### SMART Self Test

Run SMART self test on all HDDs during POST.

### 4.3.7 IT8786 Super IO Configuration

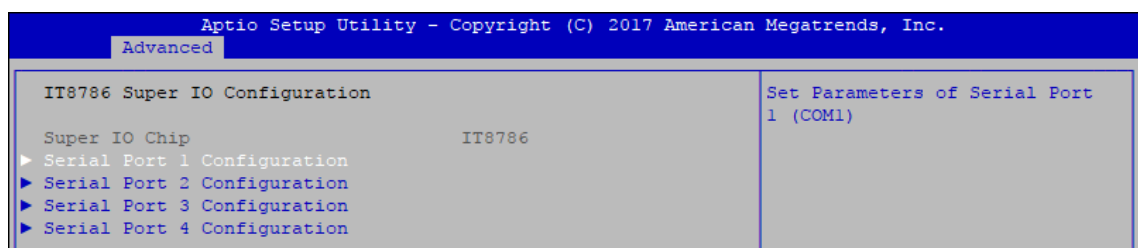

Figure 4-3-7 : IT8786 Super IO Settings

### 4.3.7.1 Serial Port X Configuration

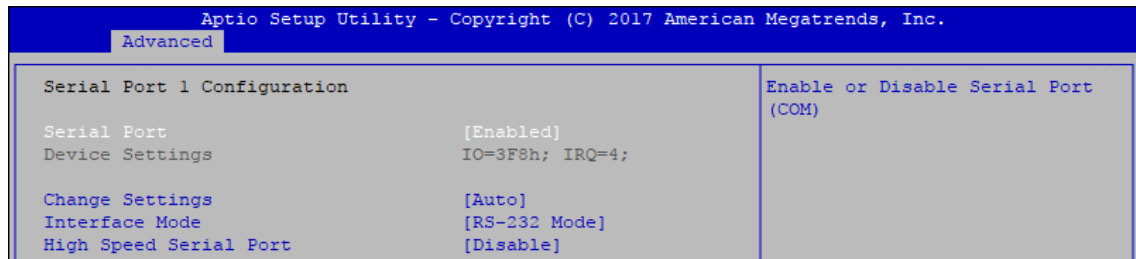

Figure 4-3-7-1 : Serial Port X Configuration

### Serial Port 1 to port 4 Configuration

Options for Serial Port 1 to Serial Port 4.

Entering the corresponding Port option then end user can change the settings such as I/O resource and UART mode (High Speed Serial Port is Port 1 only).

### 4.3.8 Hardware Monitor

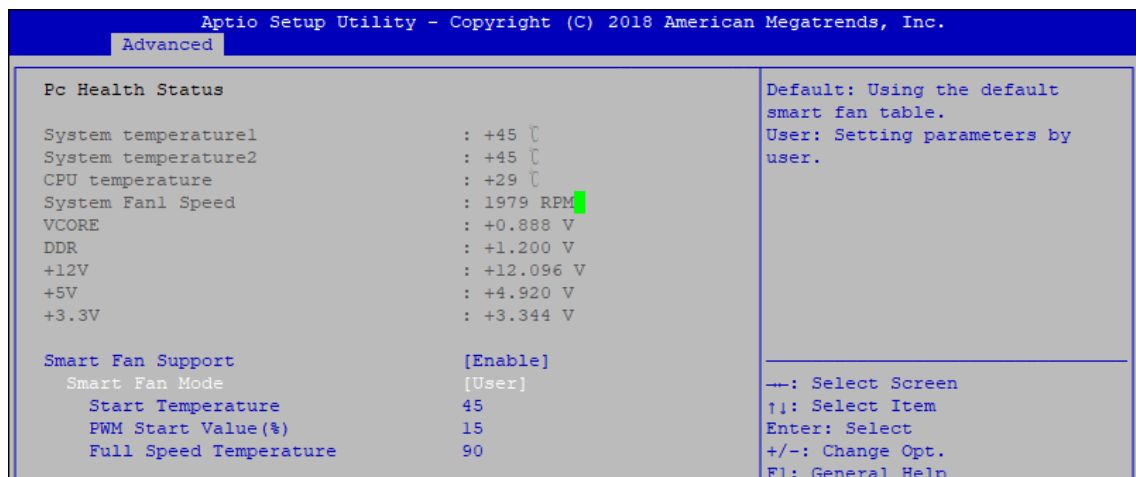

Figure 4-3-8 : Hardware Monitor Settings

The IT8786 SIO features an enhanced hardware monitor providing thermal, fan speed, and system voltages' status monitoring.

#### Smart Fan Support

Smart Fan Support. Work with Full Speed if "Smart Fan Support" is Disabled.

#### Smart Fan Mode

Default : Using the default smart fan table.

User : Setting parameters by user.

#### Start Temperature

Temperature Limit value of Fan Start (Degree C).

(Range : 10~80)

#### PWM Start Value (%)

Default PWM Value of Fan.

(Range : 15%~100%)

#### Full Speed Temperature

Temperature Limit value of Fan Full Speed (Degree C).

(Range : 50~90)

### 4.3.9 Serial Port Console Redirection

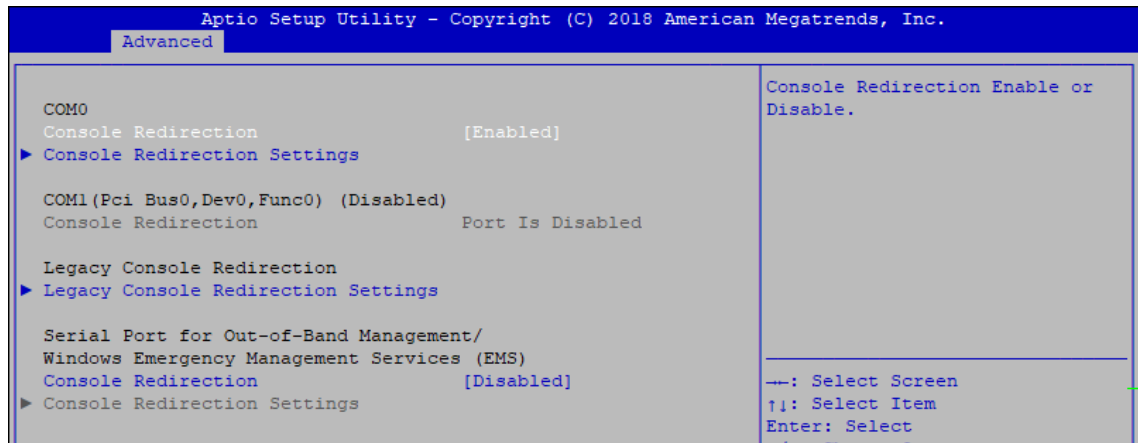

Figure 4-3-9 : Serial Port Console Redirection Settings

#### Console Redirection

Console redirection enable or disable.

#### Console Redirection Settings

These settings specify how the host computer and the remote computer (which the user is using) will exchange data. Both computers should have the same or compatible settings.

#### Legacy Console Redirection

Legacy Console Redirection Settings.

#### Serial Port for Out-of-Band Management/Windows Emergency Management Services (EMS)

Console redirection enable or disable.

### 4.3.10 Intel TXT Information

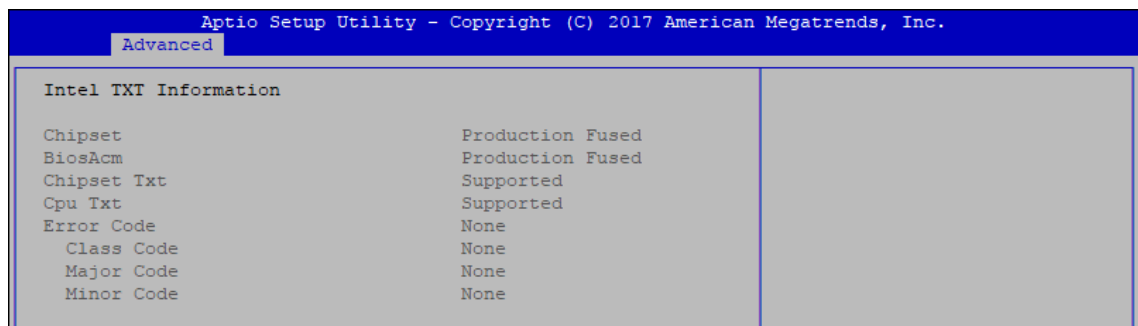

Figure 4-3-10 : Intel TXT Information

Display Intel TXT information.

### 4.3.11 Acoustic Management Configuration

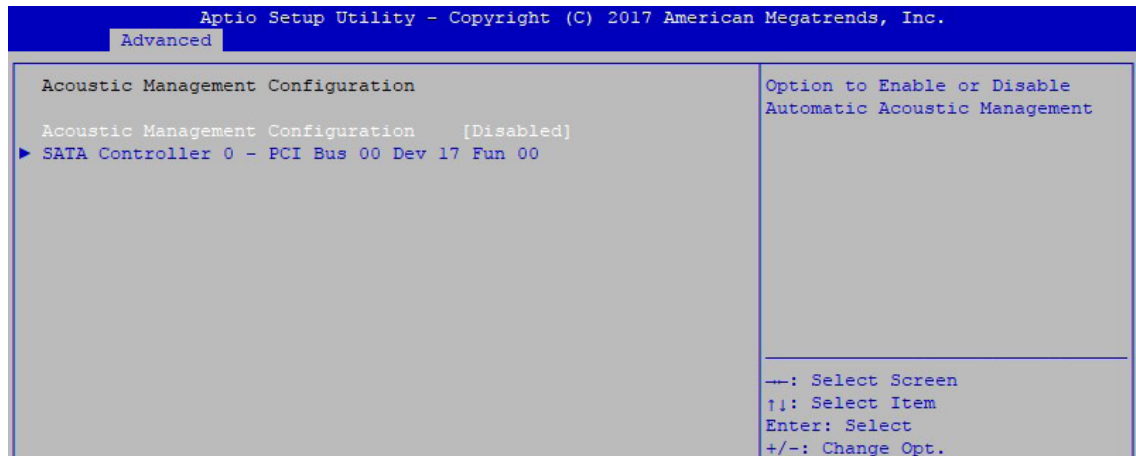

Figure 4-3-11 : Acoustic Management Settings

#### Acoustic Management Configuration

Option to enable or disable automatic acoustic management.

### 4.3.12 PCI Subsystem Setting

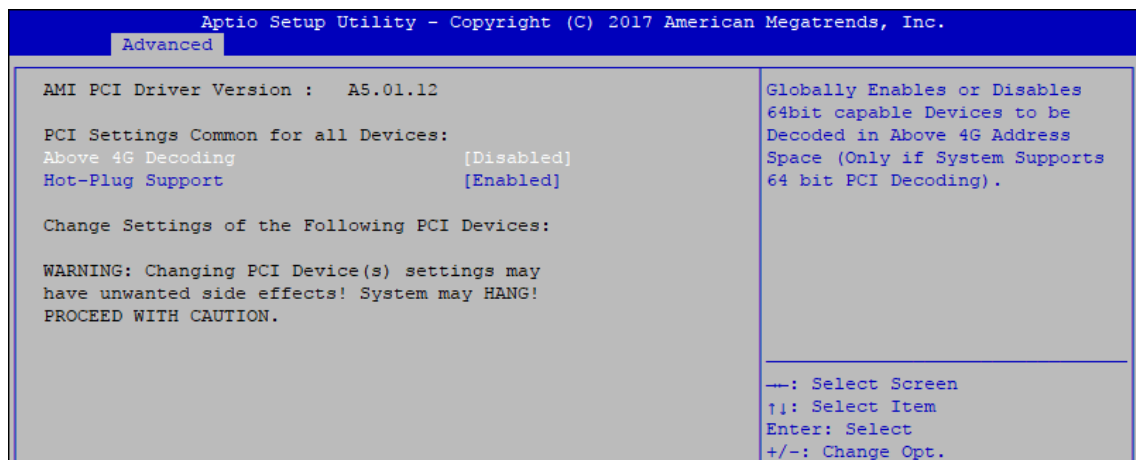

Figure 4-3-12 : PCI Subsystem Settings

#### Above 4G Decoding

Globally Enables or Disables 64bit capable Devices to be Decoded in Above 4G Address Space (Only if System Supports bot PCI Decoding)

#### Hot-Plug Support

Globally Enables or Disables Hot-Plug support for the entire System. If system has Hot-Plug Capable Slots and this option set to Enabled, it provides a Setup screen for selecting PCI resource padding for Hot-Plug.

### 4.3.13 Network Stack Configuration

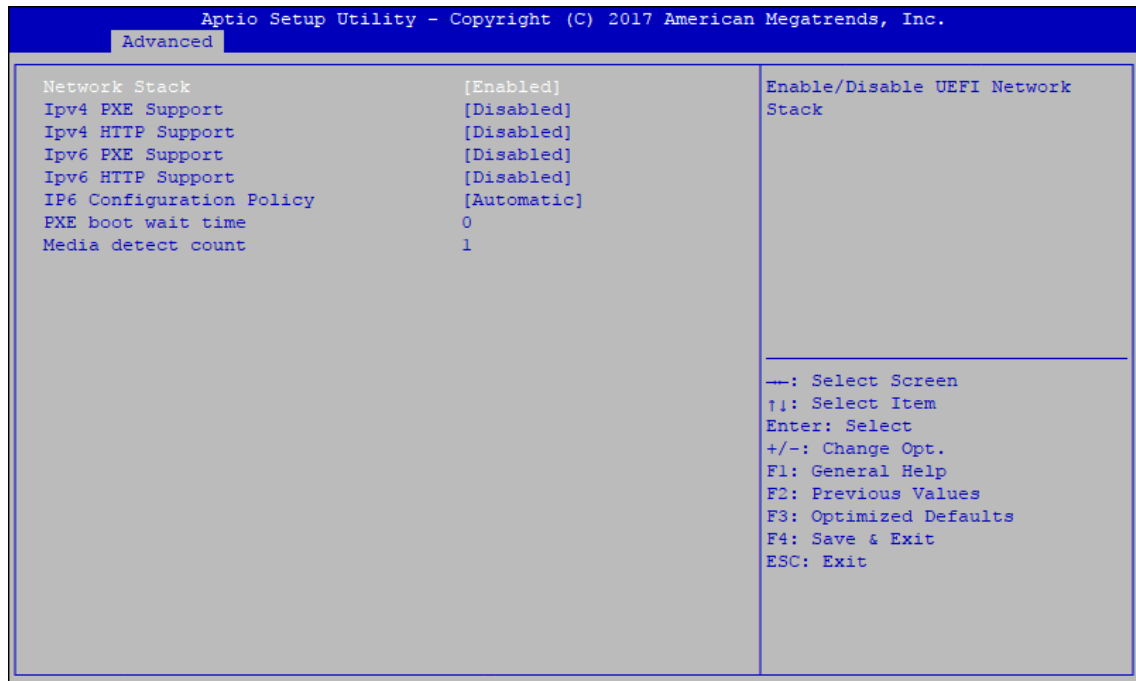

Figure 4-3-13 : Network Stack Settings

#### **Network Stack**

Enable/Disable UEFI Network Stack

#### **Ipv4 PXE Support**

Enable/Disable IPv4 PXE boot support.

#### **Ipv4 HTTP Support**

Enable/Disable IPv4 HTTP boot support.

#### **Ipv6 PXE Support**

Enable/Disable IPv6 PXE boot support.

#### **Ipv6 HTTP Support**

Enable/Disable IPv6 HTTP boot support.

#### **IP6 Configuration Policy**

Set IP6 Configuration Policy.

#### **PXE boot wait time**

Wait time to press ESC key to abort the PXE boot.

#### **Media detect count**

Number of times presence of media will be checked.

### 4.3.14 CSM Configuration

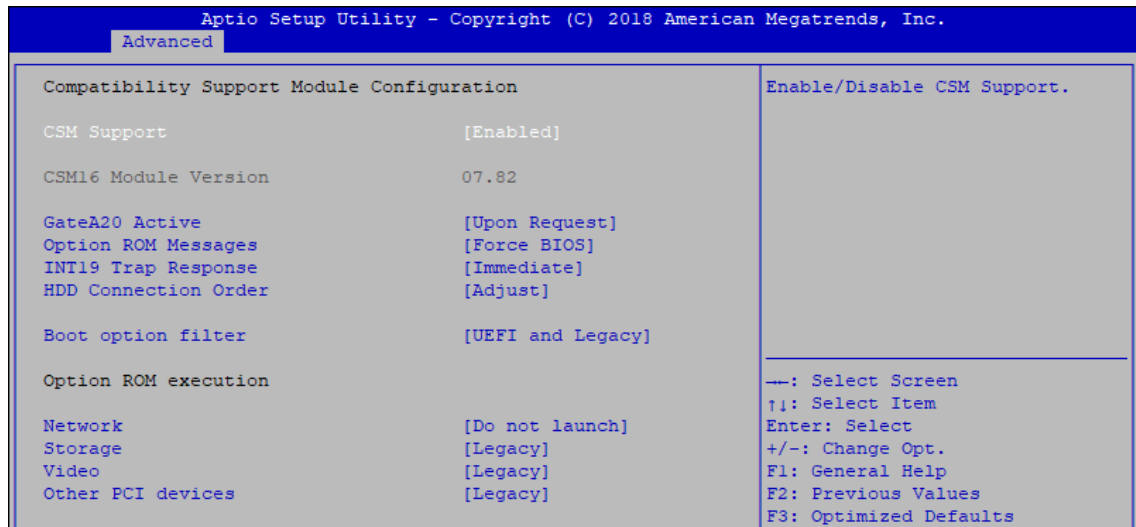

Figure 4-3-14 : CSM Settings

#### CSM Support

Enable/disable CSM support

#### GateA20 Active

UPON REQUEST - GA20 can be disabled using BIOS services.

ALWAYS - do not allow GA20 to be disabled; this option is useful when any RT code is executed above 1MB.

#### Option ROM Messages

Set display mode for Option ROM.

#### INT19 Trap Response

BIOS reaction on INT19 trapping by Option ROM :

IMMEDIATE - execute the trap right away;

POSTPONED - execute the trap during legacy boot.

#### HDD Connection Order

Some OS require HDD handles to be adjusted, i.e. OS is installed on drive 80h.

#### Boot option filter

This option controls Legacy/UEFI ROM's priority.

#### Network

Controls the execution of UEFI and Legacy PXE OpROM.

#### Storage

Controls the execution of UEFI and Legacy Storage OpROM.

#### Video

Allows more than two frequency ranges to be supported.

#### Other PCI devices

Determines OpROM execution policy for devices other than network, storage, or video.

### 4.3.15 NVMe Configuration

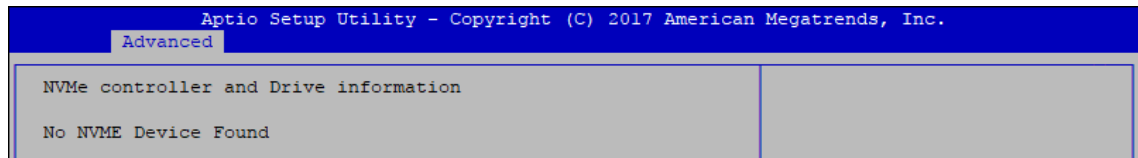

Figure 4-3-15 : NVMe Settings

Display NVMe controller and Drive information.

### 4.3.16 USB Configuration

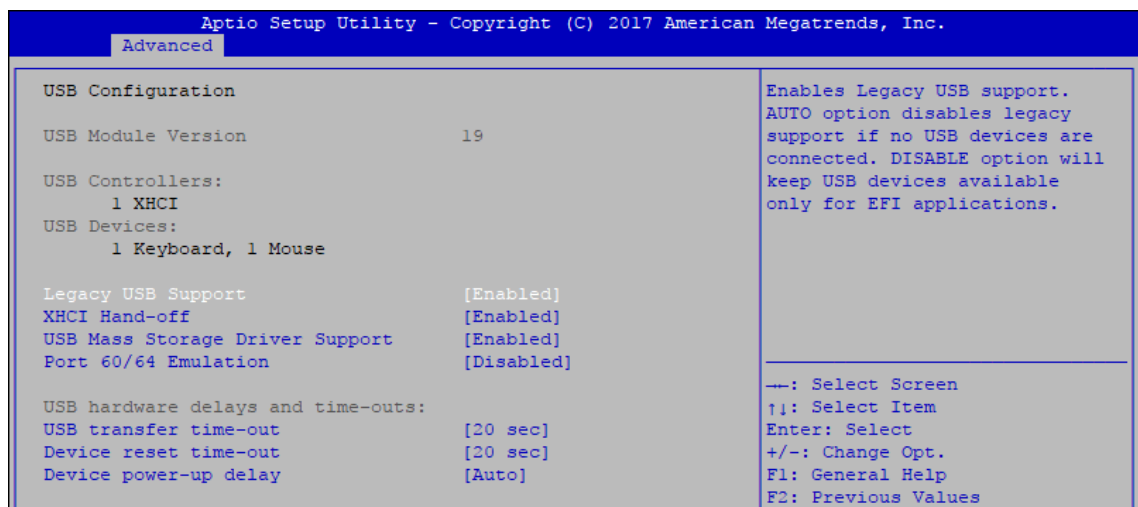

Figure 4-3-16 : USB Settings

#### Legacy USB Support

Enables Legacy USB support.

AUTO option disables Legacy support if no USB devices are connected.

DISABLE option will keep USB devices available only for EFI applications.

#### XHCI Hand-off

This is a workaround for OS-es without XHCI hand-off support. The XHCI ownership change should be claimed by XHCI driver.

#### USB Mass Storage Driver Support

Enable/disable USB mass storage driver support.

#### Port 60/64 Emulation

Enables I/O port 60h/64h emulation support. This should be enabled for the complete USB keyboard legacy support for non-USB aware OSes.

#### USB transfer time-out

The time-out value for control, bulk, and interrupt transfers.

#### Device reset time-out

USB mass storage device start unit command time-out.

#### Device power-up delay

Maximum time the device will take before it properly reports itself to the Host Controller. 'Auto' uses default value, for a root port it is 100 ms, for a hub port the delay is taken from the hub descriptor.



## 4.4 Chipset

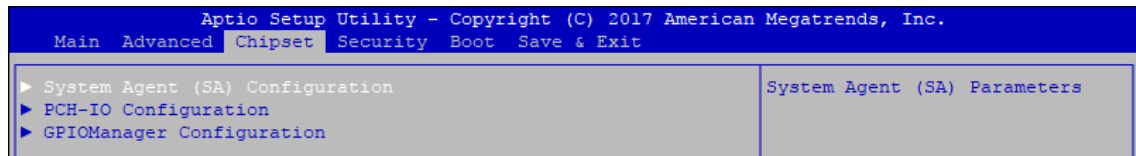

Figure 4-4 : BIOS Chipset Menu

### System Agent (SA) Configuration

System Agent (SA) parameters.

### PCH-IO Configuration

PCH parameters.

### GPIOManager Configuration

GPIOManager Configuration.

### 4.4.1 System Agent (SA) Configuration

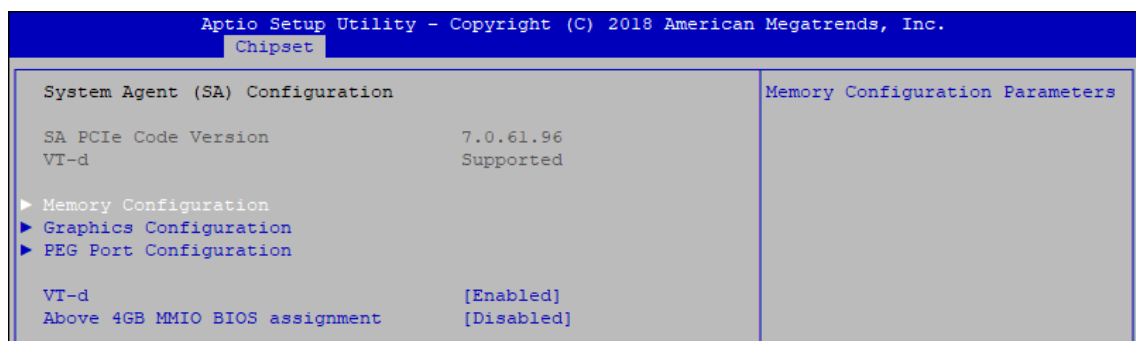

Figure 4-4-1 : System Agent Settings

#### VT-d

VT-d capability.

#### Above 4GB MMIO BIOS assignment

Enable/disable above 4GB MemoryMappedIO BIOS assignment. This is disabled automatically when aperture size is set to 2048MB.

### 4.4.1.1 Memory Configuration

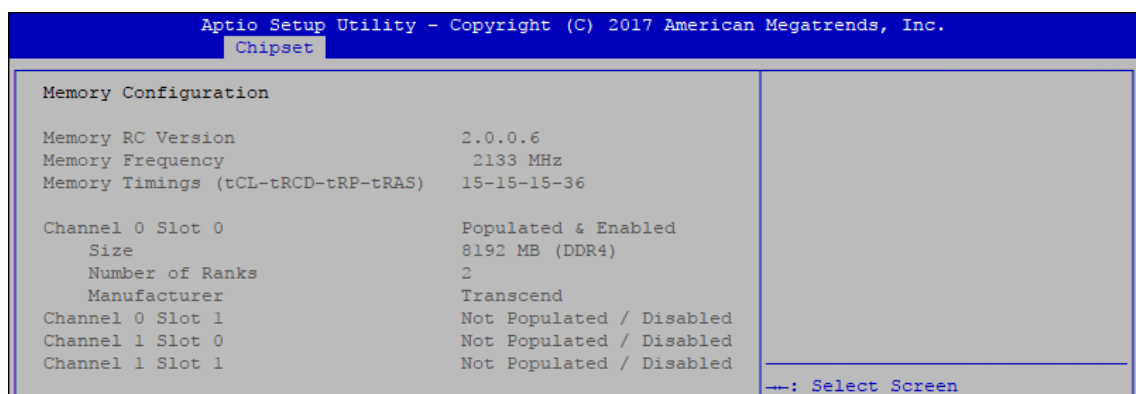

Figure 4-4-1-1 : Memory Information

Displays memory information.

## 4.4.1.2 Graphics Configuration

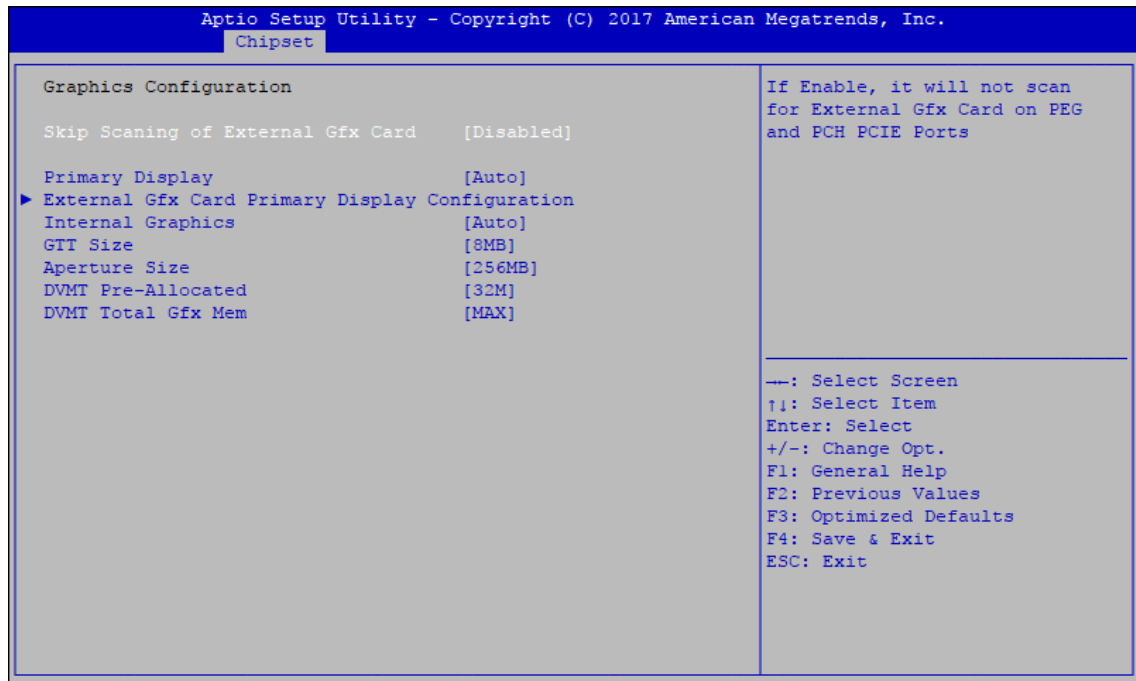

Figure 4-4-1-2 : Graphics Settings

### Skip Scanning of External Gfx Card

If Enable, it will not scan for External Gfx Card on PEG and PCH PCIE Ports.

### Primary Display

Select which of IGFX/PEG/PCI Graphics device should be Primary Display Or select SG for Switchable Gfx.

### Internal graphics

Keep IGFX enabled based on the setup options.

### GTT Size

Select the GTT Size.

### Aperture Size

Select the Aperture Size.

Note : Above 4GB MMIO BIOS assignment is automatically enabled when selecting 2048MB aperture. To use this feature, please disable CSM Support.

### DVMT Pre-Allocated

Select DVMT 5.0 Pre-Allocated (Fixed) Graphics Memory size used by the Internal Graphics Device.

### DVMT Total Gfx Mem

Select DVMT5.0 Total Graphic Memory size used by the Internal Graphics Device.

### 4.4.1.3 PEG Port Configuration

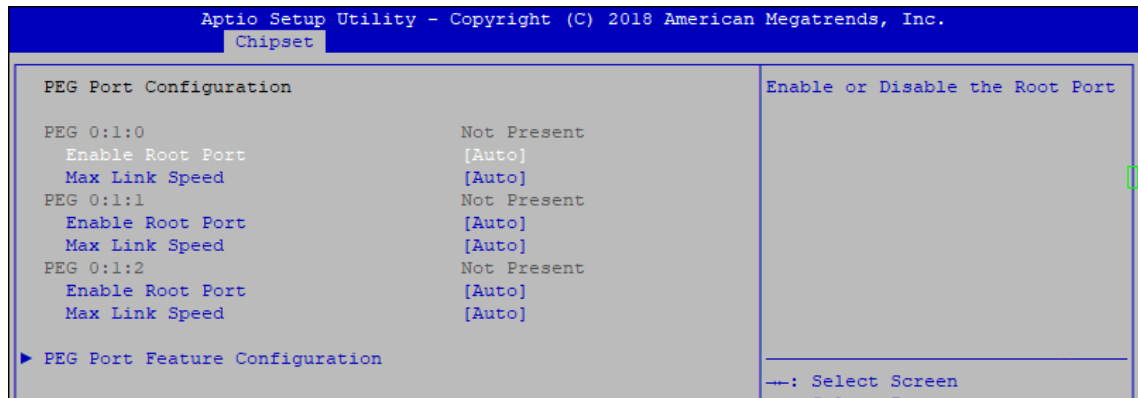

Figure 4-4-1-3 : PEG Port Configuration

PEG port options for PCIe device.

### 4.4.2 PCH-IO Configuration

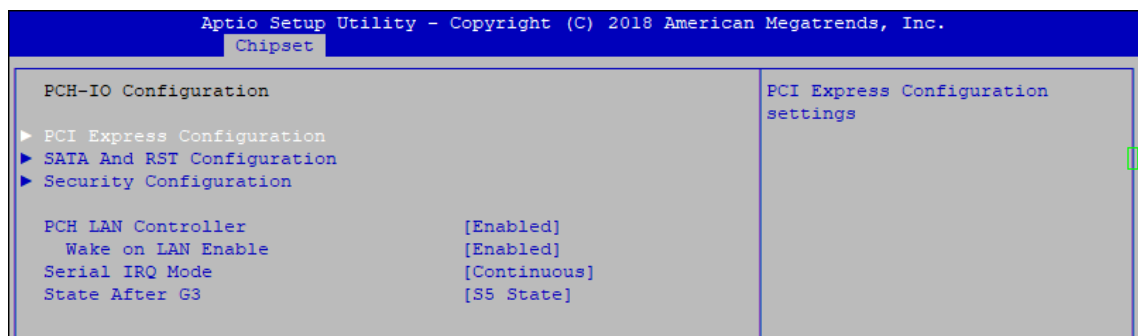

Figure 4-4-2 : PCH-IO Settings

#### PCH LAN Controller

Enable or disable onboard NIC.

#### Wake on LAN

Enable or disable integrated LAN to wake the system. (The wake On LAN cannot be disabled if ME is on at Sx state.)

#### Serial IRQ Mode

Configure serial IRQ mode.

#### State After G3

Specify what state to go to when power is re-applied after a power failure (G3 state).

S0 State : Always turn-on the system when power source plugged-in.

S5 State : Always turn-off the system when power source plugged-in.

## 4.4.2.1 PCI Express Configuration of PCH-IO

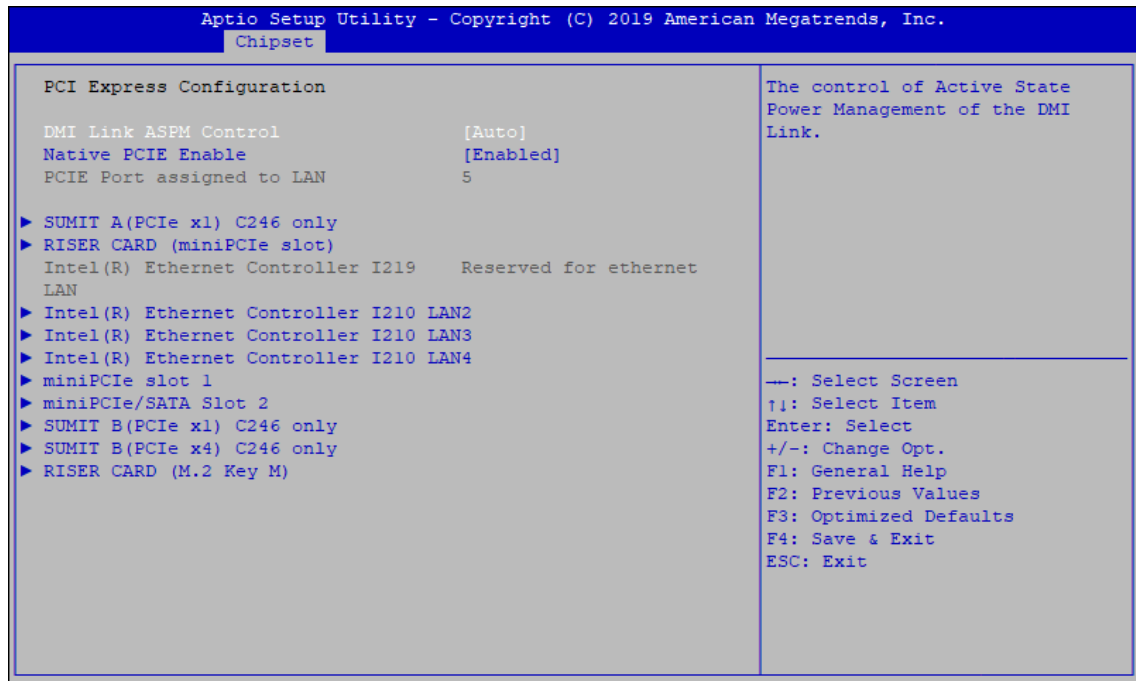

Figure 4-4-2-1 : PCH-IO Settings

### DMI Link ASPM Control

Enable/Disable the control of Active State Power Management on SA side of the DMI Link.

### Native PCIE Enable

PCIE Express Native Support Enable/Disable.

### PCI Express device settings

Bios options for PCI Express device setting.

## 4.4.2.2 SATA and RST Configuration

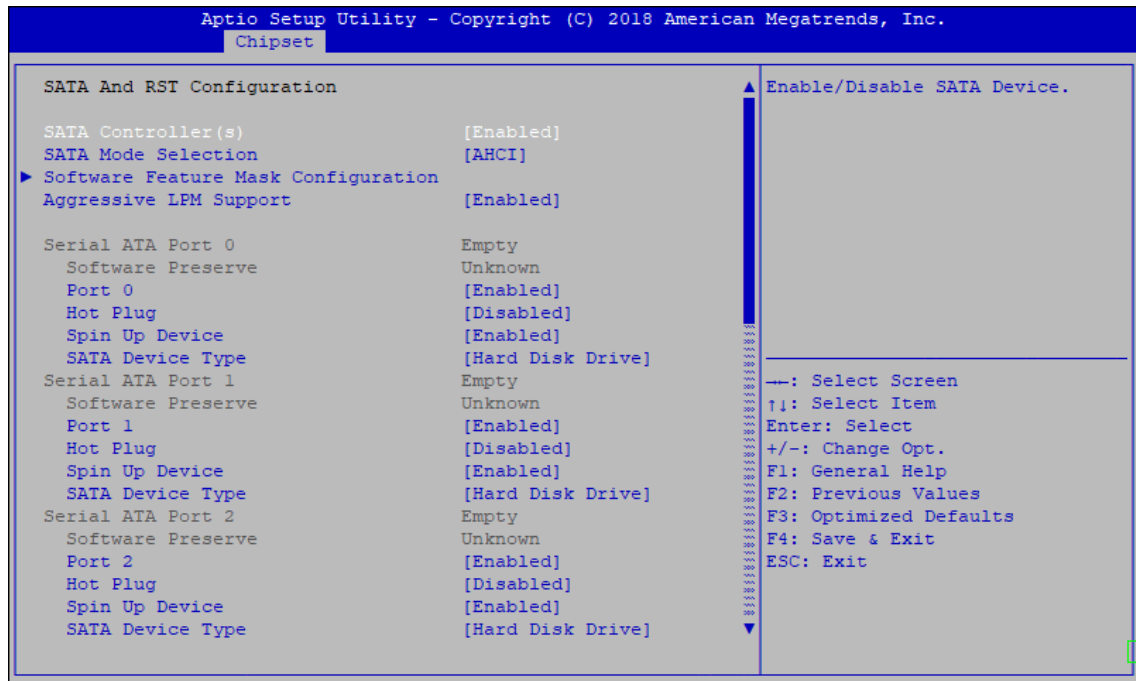

Figure 4-4-2-2 : SATA and RST Settings

### SATA Controller(s)

Enable or disable SATA Device.

### SATA Mode Selection

Determines how SATA controller(s) operate.

### Aggressive LPM Support

Enable PCH to aggressively enter link power state.

### Options for each SATA port :

Port n

Enable or disable SATA Port.

### Hot Plug

Designated this port as Hot Pluggable.

### Spin Up Device

On an edge detect from 0 to 1, the PCH starts a COMRESET initialization sequence to the device.

### SATA Device Type

Identifies that the SATA port is connected to solid state drive or hard disk drive.

### 4.4.2.3 Security Configuration

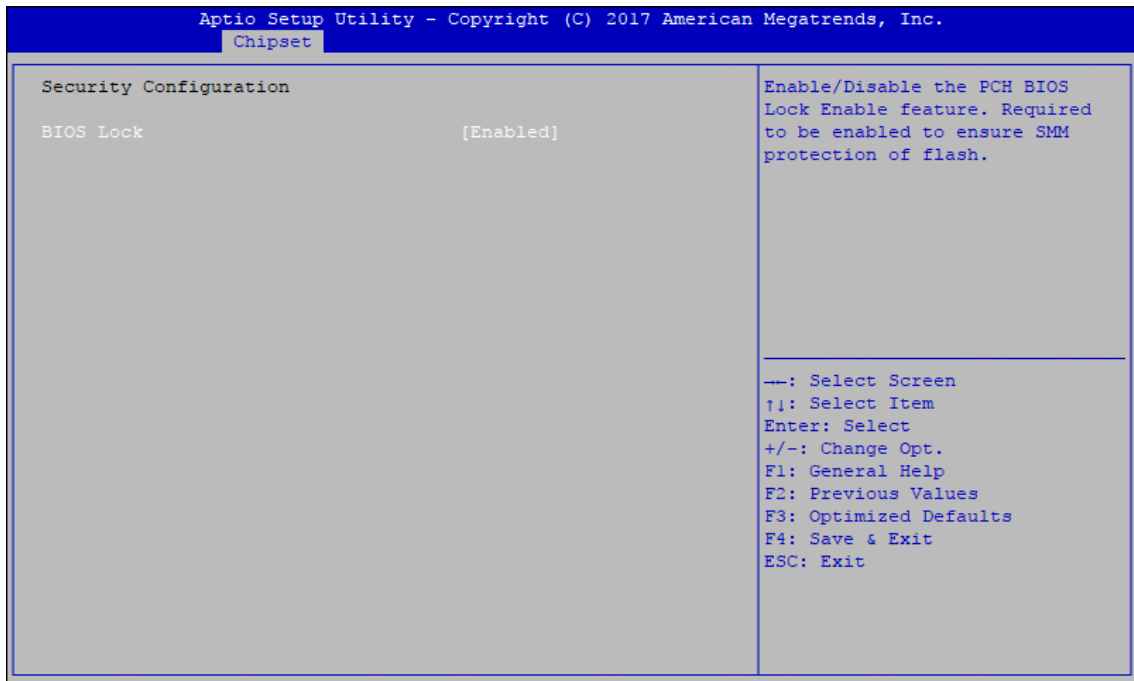

Figure 4-4-2-3 : Security Settings

#### **BIOS Lock**

Enable/disable the PCH BIOS Lock Enable (BLE bit) feature.

## 4.5 Security

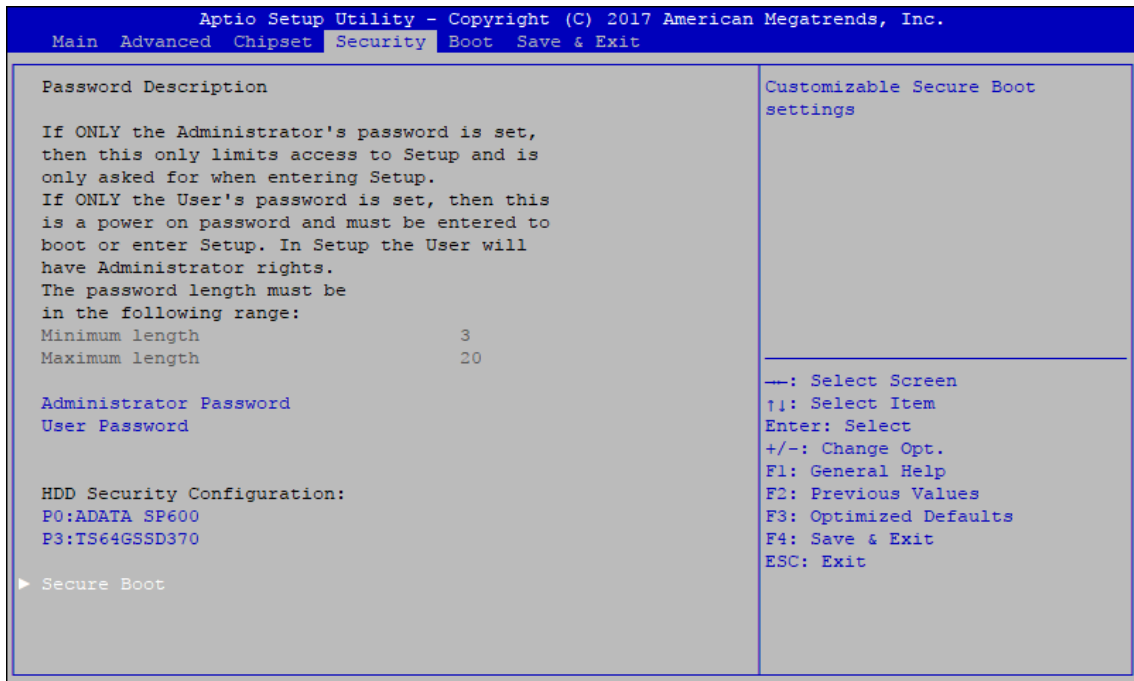

Figure 4-5 : BIOS Security Menu

### Administrator Password

Set administrator password.

### User Password

Set user password.

### Secure Boot

Customizable Secure Boot Settings.

## 4.5.1 HDD Security Configuration

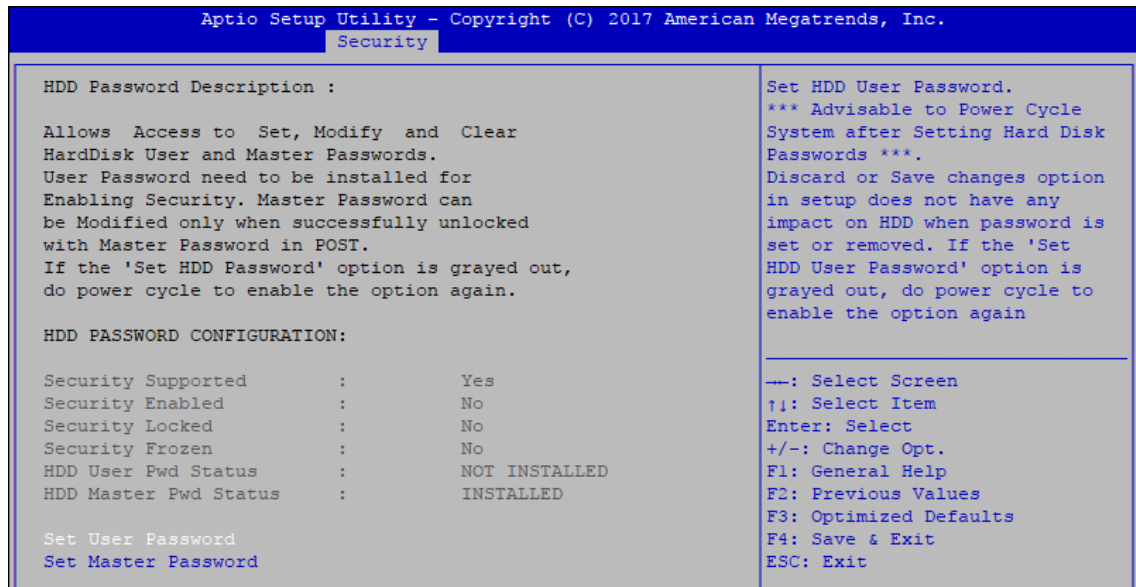

Figure 4-5-1 : HDD Security Settings

### Set User Password

Set HDD user password.

\*\*\* Advisable to power cycle system after setting hard disk passwords \*\*\*

Discard or save changes option in setup does not have any impact on HDD when password is set or removed. If the 'Set HDD User Password' option is gray, do power cycle to enable the option again.

## 4.5.2 Security Boot

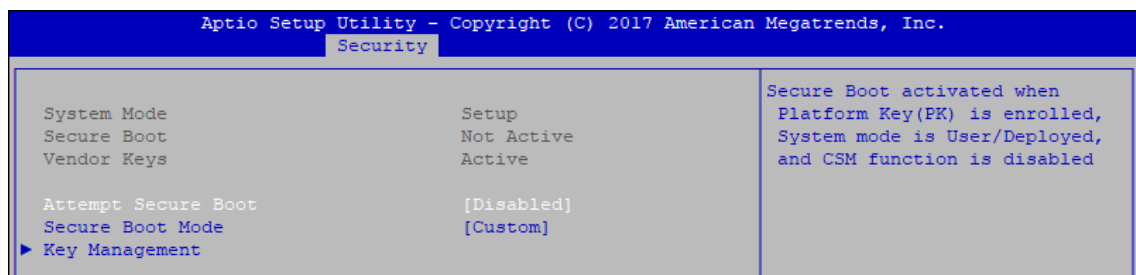

Figure 4-5-2 : Security Boot Settings

### Attempt Secure Boot

Secure Boot activated when Platform Key (PK) is enrolled, System mode is User/Deployed, and CSM function is disabled.

### Secure Boot Mode

Secure Boot mode selector Standard/Custom.

In custom mode Secure Boot Variables can be configured without authentication

### Key Management

Enables expert users to modify Secure boot policy variables without full authentication



## 4.6 Boot

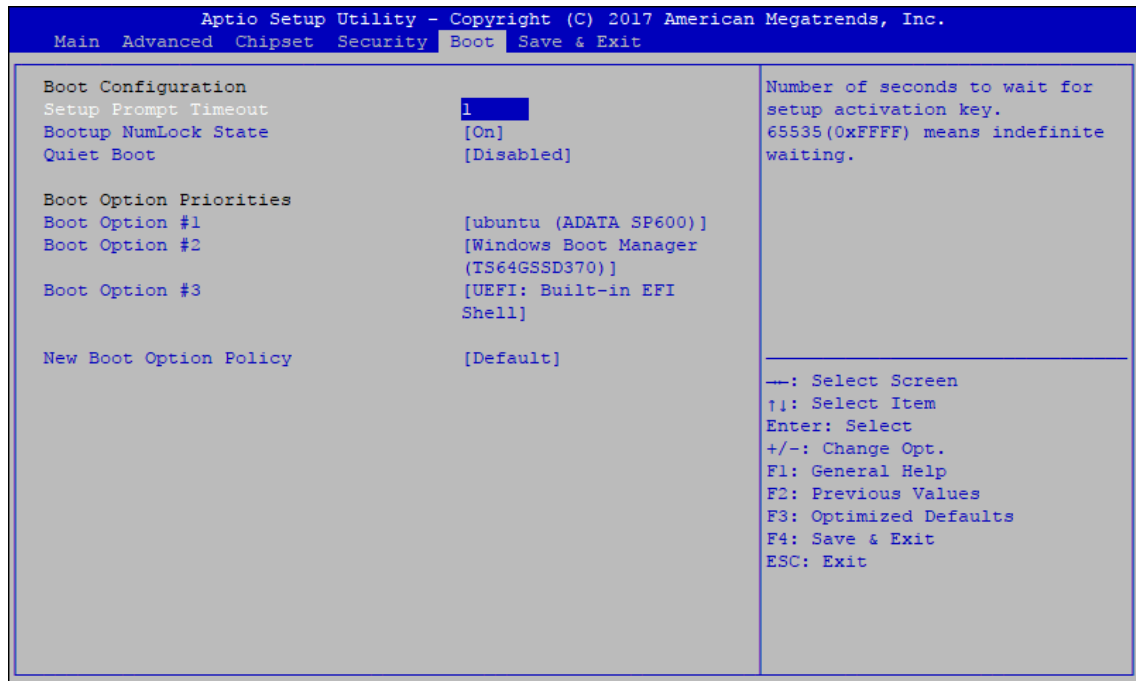

Figure 4-6 : BIOS Boot Menu

### Setup Prompt Timeout

Number of seconds to wait for setup activation key. 65535 (0xFFFF) means indefinite waiting.

### Bootup NumLock State

Select the keyboard NumLock state.

### Quiet Boot

Enables or disables Quiet Boot option.

### Boot Option

Sets the system boot order.

### New Boot Option Policy

Controls the placement of newly detected UEFI boot options.

### Hard Drive BBS Priorities

Set the order of the Legacy devices in this group.

## 4.7 Save & Exit

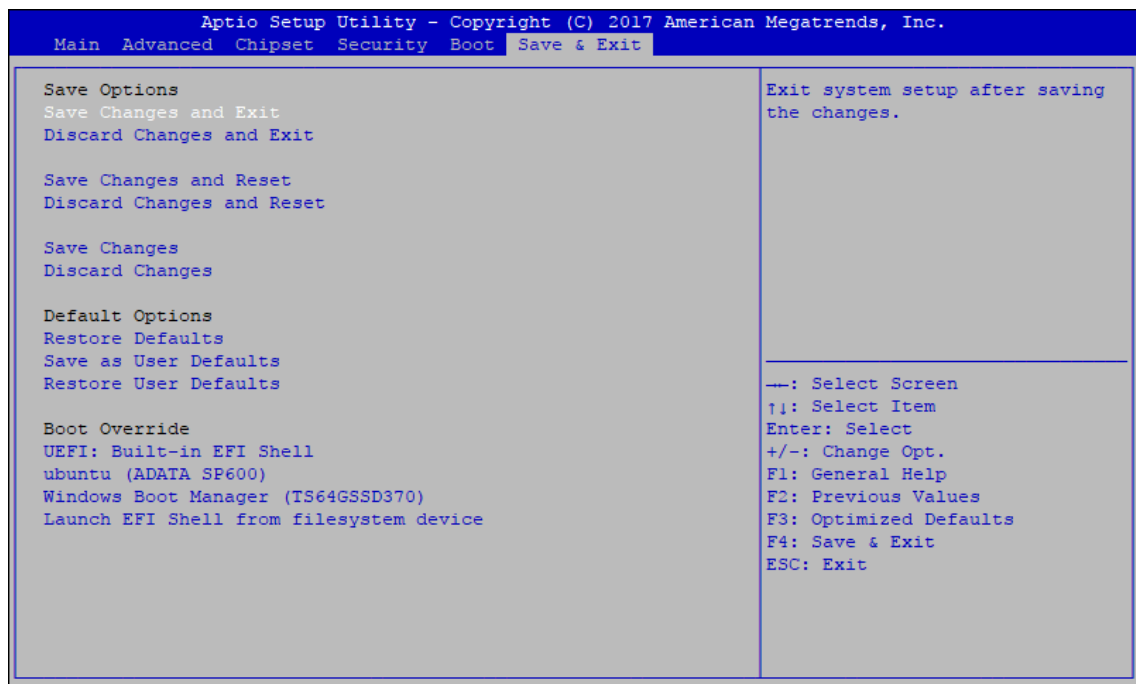

Figure 4-7 : BIOS Save and Exit Menu

### Save Changes and Exit

Exit system setup after saving the changes.

### Discard Changes and Exit

Exit system setup without saving any changes.

### Save Changes and Reset

Reset the system after saving the changes.

### Discard Changes and Reset

Reset system setup without saving any changes.

### Save Changes

Save Changes done so far to any of the setup options.

### Discard Changes

Discard Changes done so far to any of the setup options.

Default Options

### Restore Defaults

Restore/Load Default values for all the setup options.

### Save as User Defaults

Save the changes done so far as User Defaults.

### Restore User Defaults

Restore the User Defaults to all the setup options

# A

## APPENDIX A : SOFTWARE GUIDE

### A.1 Function Description

The SPC-5600 offers a watchdog timer.

### A.2 Software Package Contain

Distribution folder include x32 and x64 versions, use batch file for installation.

There are included as followed :

Win7\_32.bat :

Installation for 32-bit driver

Win7\_64.bat :

Windows update package which driver required (need to restart), and Installation for 64-bit driver

Win8\_32.bat, Win8\_64.bat :

Installation for driver, and guideline to Framework 3.5 distribution for sample

Win10\_32.bat, and Win10\_64.bat :

Installation for driver, and installation to Framework 3.5 distribution for sample

Uninstall\_32.bat, and Uninstall\_64.bat :

Uninstallation for driver

Run batch file as Administrator.

Support Windows 7 above.

Make sure Windows version before installation.

Runtime folder include head file for software developer or System Integration.

Sample folder include sample program, driver library, and API library.

Source folder include sample program source code that compile on Visual Studio 2008.

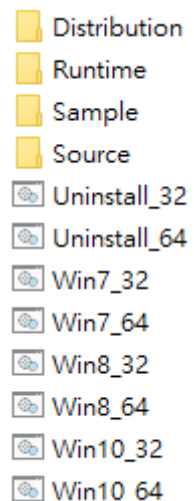

## A.3 Sample

Sample folder include x32 and x64 versions, as shown below :



Sample SPC-5600.exe, as shown below :

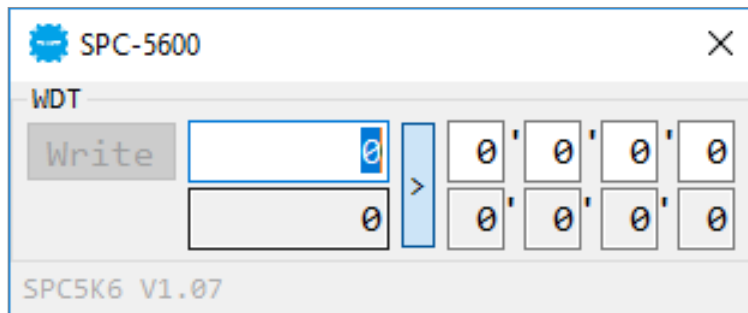

### WDT group :

Write button :

Set WDT when WDT setup text is valid.

Stop button :

Cancel WDT and counting.

Use after Write button action.

WDT setup text :

User setting, WDT value, unit : second.

Use for Write button activate.

WDT counting text (read only) :

WDT counting by program timer after set WDT.

Shown after Write button action.

WDT setup day format texts (user setting) :

User setting, WDT value, format : day'hour'minute'second.

WDT counting day format text (read only) :

WDT counting, format : day'hour'minute'second.

# B

## APPENDIX B : Software Functions

### B.1 Driver API Guide

In Runtime folder, on SPC5K6.h :

\_DLL\_IMPORT\_ definition is used on LoadLibrary API for SPC5K6.dll.  
SPC5K6\_EXPORTS definition is used on SPC5K6.dll building.

#### **BOOL Initial()**

Initial machine for watchdog timer

Return :

TRUE (1) : Success;

FALSE (0) : Fail (Driver not exists, or initial error (version is too old, or machine not match))

#### **BOOL GetWDT(DWORD \*WDT)**

Get watchdog timer setup

WDT : watchdog timer setup

Unit : second. (Range : 0 ~ 65535 sec, 1093 ~ 65535 min (=65580 ~ 3932100 sec))

Return :

TRUE (1) : Success;

FALSE (0) : Fail (Initial error, or call by pointer error, or hardware problem)

#### **BOOL SetWDT(DWORD WDT)**

Set watchdog timer setup

WDT : watchdog timer setup

Unit : second. (Range : 1 ~ 65535 sec, 1093 ~ 65535 min (=65580 ~ 3932100 sec))

Return :

TRUE (1) : Success;

FALSE (0) : Fail (Initial error, or setup 0 error, or hardware problem)

#### **BOOL CancelWDT()**

Cancel watchdog timer

Return :

TRUE (1) : Success;

FALSE (0) : Fail (Initial error, or hardware problem)



## APPENDIX C : Power Consumption

Testing Board	SPC-5600
RAM	16GB X 2
USB-1	USB Keyboard Microsoft Wired Keyboard 600
USB-2	USB Mouse Logitech M105
USB-3	USB Flash Transecnd 3.0 8GB
USB-4	USB Flash Transcend 3.0 8GB
CFAST	N/A
SATA 0	INTEL E5400S 120GB
SATA 1	WD WD5000BPVT 500GB
LAN 1 (i219)	1.0 Gbps
LAN 2 (i210)	1.0 Gbps
Graphics Output	DVI
Power Plan	Balance (Windows 10 Power plan)
Power Source	Chroma 62006P-100-25
Power Source	Chroma 62006P-100-25
Test Program-1	BurnInTest
Test Program-2	FurMark

## C.1 Intel® Xeon® E-2176G (12M Cache, 3.70GHz)

CPU	Power Input	Standby Mode		Power on and boot to Win 10 (64-bit)			
				Sleep Mode		idle status CPU usage less 3%	
		Max Current	Max Consumption	Max Current	Max Consumption	Max Current	Max Consumption
Xeon® E-2176G	12V	0.220A	02.64W	0.310A	03.72W	1.126A	13.51W

CPU	Power Input	Power on and boot to Win10 (64-bit)			
		Run 100% CPU usage without 3D		Run 100% CPU usage with 3D	
		Max Current	Max Consumption	Max Current	Max Consumption
Xeon® E-2176G	12V	5.740A	68.88W	7.716A	92.59W

## C.2 Intel® Core™ i7-8700 (12M Cache, 3.20GHz)

CPU	Power Input	Standby Mode		Power on and boot to Win 10 (64-bit)			
				Sleep Mode		idle status CPU usage less 3%	
		Max Current	Max Consumption	Max Current	Max Consumption	Max Current	Max Consumption
Core™ i7-8700	12V	0.236A	02.83W	0.307A	03.68W	1.071A	12.85W

CPU	Power Input	Power on and boot to Win10 (64-bit)			
		Run 100% CPU usage without 3D		Run 100% CPU usage with 3D	
		Max Current	Max Consumption	Max Current	Max Consumption
Core™ i7-8700	12V	4.173A	50.08W	6.844A	82.13W

## C.3 Intel® Core™ i7-8700T (12M Cache, 2.40GHz)

CPU	Power Input	Standby Mode		Power on and boot to Win 10 (64-bit)			
				Sleep Mode		idle status CPU usage less 3%	
		Max Current	Max Consumption	Max Current	Max Consumption	Max Current	Max Consumption
Core™ i7-8700T	12V	0.226A	02.71W	0.322A	03.86W	1.058A	12.70W

CPU	Power Input	Power on and boot to Win10 (64-bit)			
		Run 100% CPU usage without 3D		Run 100% CPU usage with 3D	
		Max Current	Max Consumption	Max Current	Max Consumption
Core™ i7-8700T	12V	3.000A	36.00W	4.149A	49.79W

# D

## APPENDIX D : Supported Memory & Storage List

### D.1 Supported Memory List

Testing Board	SPC-5600
Memory Test	version : 5.1
BurnInTest	V8.1

### D.2 Supported Non-ECC Memory List

	Brand	Info	Test Temp. (Celsius)
Innodisk	4GB DDR4 2666 SODIMM	M4S0-4GSSNCIK-H03	25°C
			25°C
innodisk	8GB DDR4 2666 SODIMM	M4S0-8GSSOCIK-H03	25°C
			25°C
innodisk	8GB DDR4 2666 SODIMM	M4S0-8GS1NCIK-H03	25°C
			25°C
innodisk	16GB DDR4 2666 SODIMM	M4S0-AGS1OCIK-H03	25°C
			25°C
innodisk	16GB DDR4 2666 SODIMM	M4S0-AGS1O5IK-H03	25°C
			25°C
innodisk	4GB DDR4 2666 W/T SODIMM	M4S0-4GSSN5IK-H03	25°C
			25°C
innodisk	16GB DDR4 2666 W/T ECC SODIMM	M4D0-AGS1Q5IK-H03	25°C
			25°C
innodisk	4GB DDR4 2666 W/T ECC SODIMM	M4D0-4GSSP5IK-H03	25°C
			25°C
SLINK	DDR4 32GB 2666 SODIMM IT	J4BGSS2G8QHXI	25°C
			25° C
SLINK	DDR4 32GB 2666 ECC SODIMM	J4BGDS2G8QHKC	25°C
			25°C



## D.3 Supported Storage Device List

Type	Brand	Model	Capacity
mSATA	Intel	Intel-310 SSDMAEMC080G2	80GB
	Kingston	SUV500MS120G	120GB
SSD	Intel	SSD 530 SSDSC2BW120A4	120GB
		SSD E 5400s SSDSC2KR120H6	120GB
	LITE-ON	K8-L1512	512GB
	MEMXPRO	2.5" SSD M3A 128GB	128GB
	FORESEE	2.5" 256GB SSD SATA6.0 S903S256G	256GB
		2.5" 128GB SSD SATA6.0 S903S128G	128GB
HDD	TOSHIBA	MQ01ABF050	500GB
	HGST	HTS545050A7E680	500GB

\*\* If more help is needed, please contact Vecow Technical Support.

# E

## APPENDIX E : Install Win11 (BIOS TPM Setting)

**Step 1** Click on “Advanced”, then click on “PCH-FW Configuration”

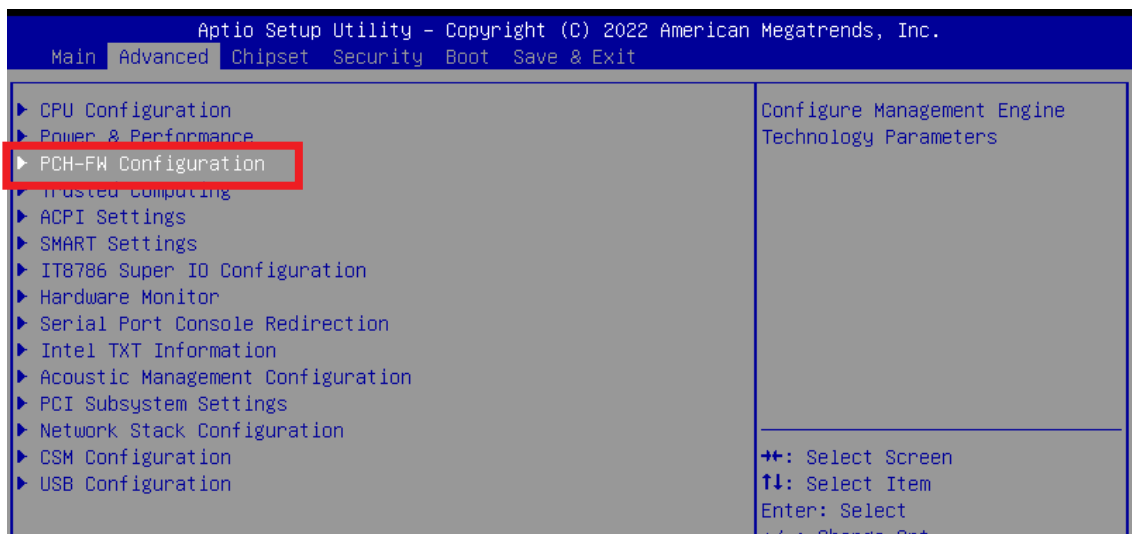

**Step 2** Click on “PTT Configuration”

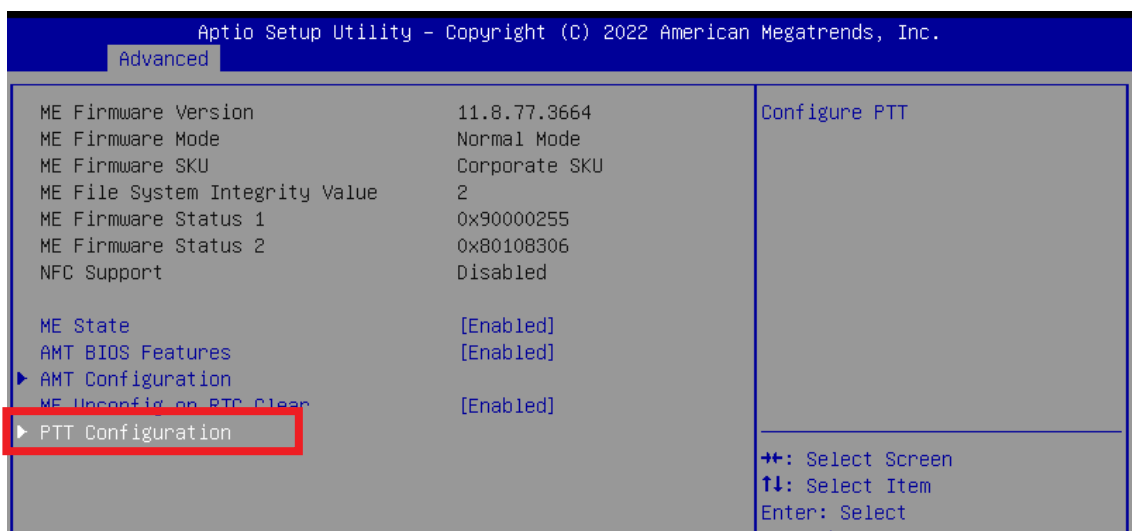

### Step 3 Click on “dTPM” (TPM Device Selection)

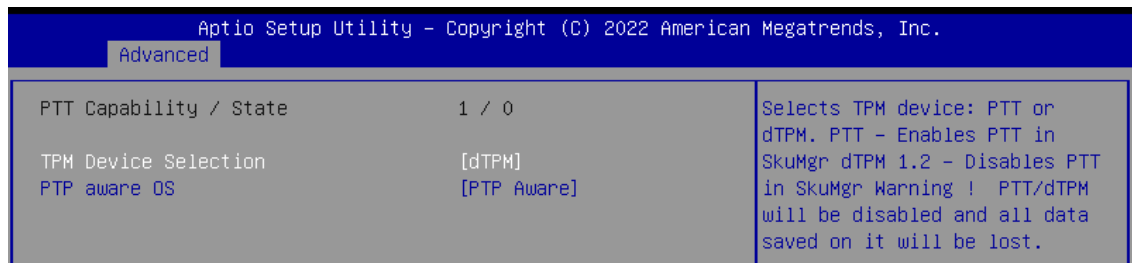
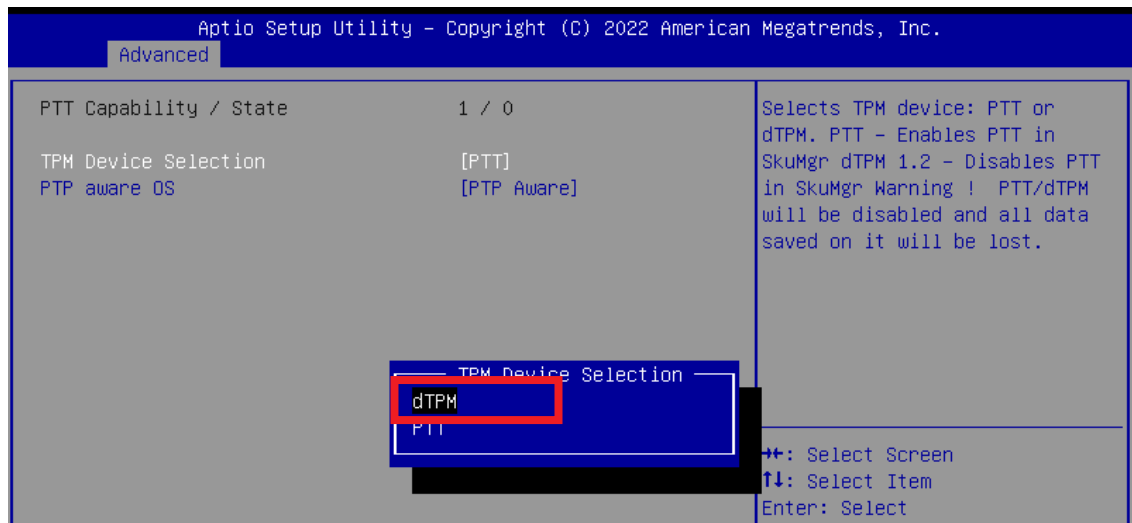

### Step 4 Please save the BIOS settings by pressing F4. Please press Enter when the pop-up window which asks “Save configuration and exit?” appears. The computer will then restart.

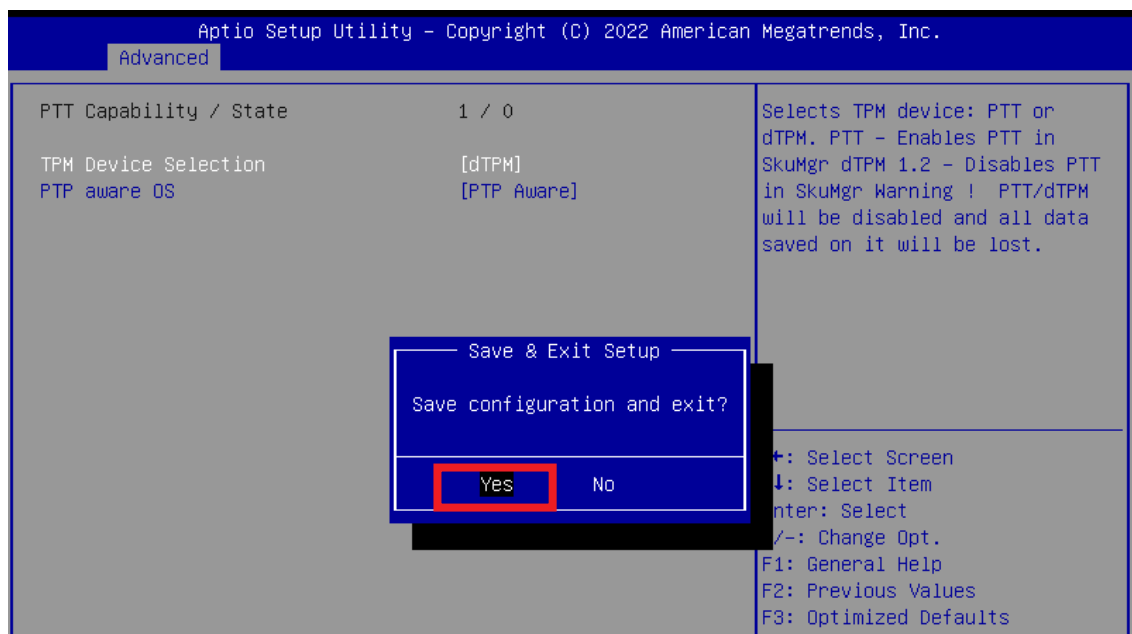

### Step 5 Click on “Trusted Computing”

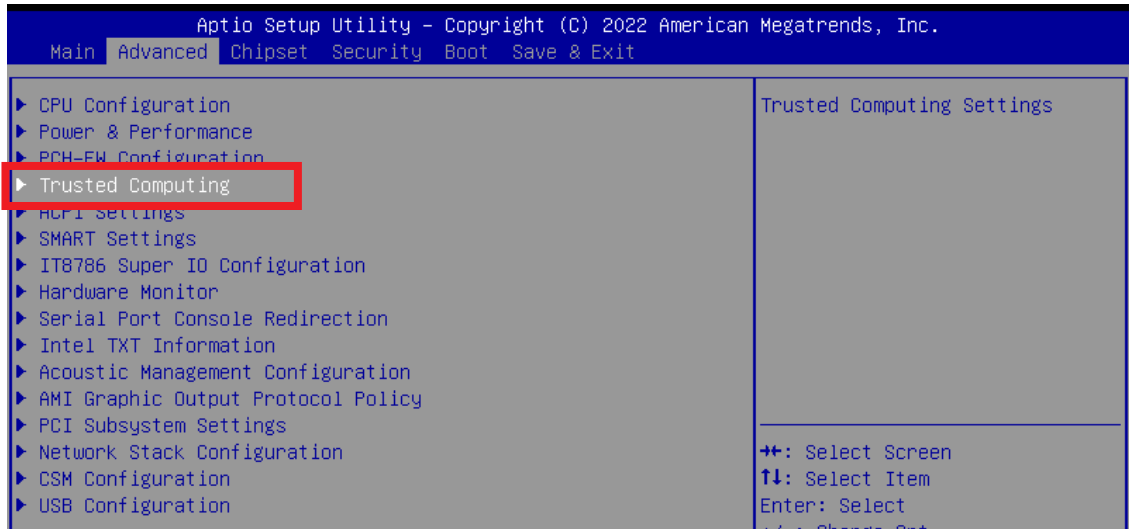

### Step 6 If the window shows “TPM2.0 Device Found Firmware Version:5.62”, then the setting is completed.

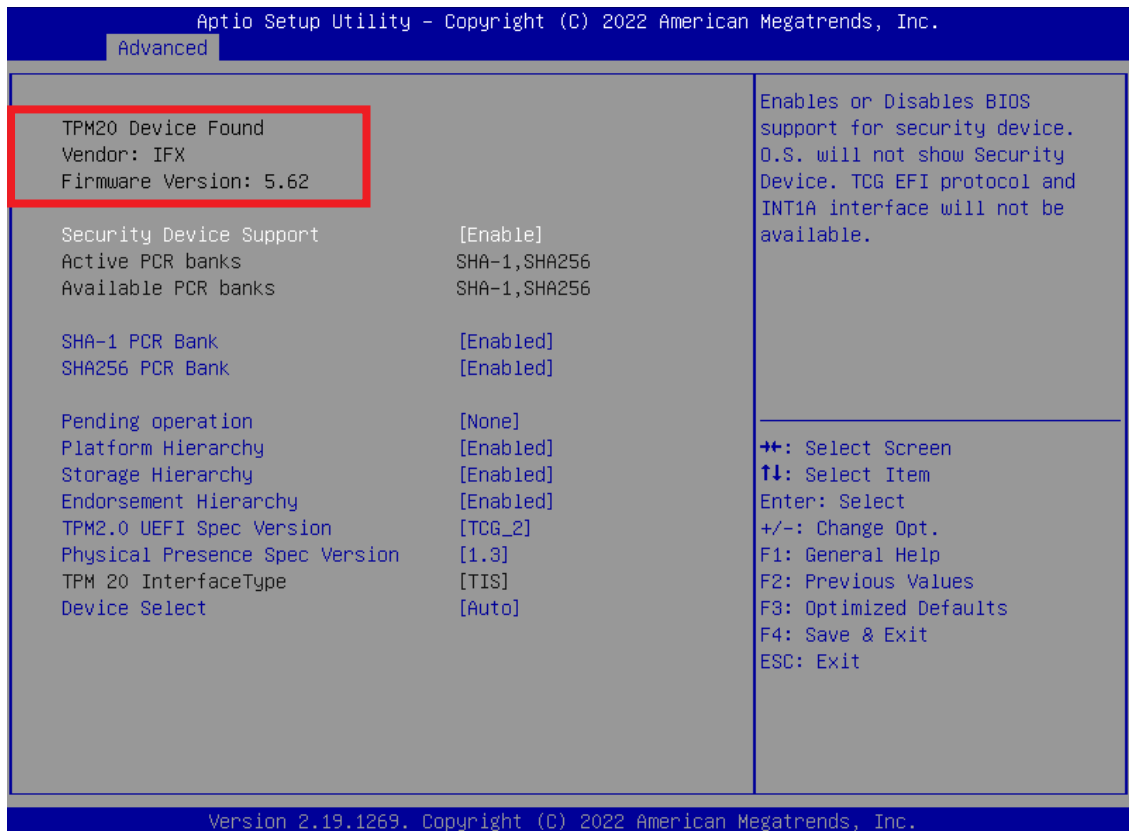

\*\* If more help is needed, please contact Vecow technical support \*\*



For further support information, please visit [www.vecow.com](http://www.vecow.com)

This document is released for reference purpose only.

All product offerings and specifications are subject to change without prior notice.

No part of this publication may be reproduced in any form or by any means, electric, photocopying, or recording, without prior authorization from the publisher.

The rights of all the brand names, product names, and trademarks belong to their respective owners.

© Vecow Co., Ltd. 2023. All rights reserved.